

AKO-16523
AKO-16523P
AKO-16523L

AKO-16520
AKO-16520P

AKO-16523D
AKO-16523-V

Temperature controller for cold rooms

User manual



AKO

Index	Page
Versions and references	3
Warnings.....	3
Maintenance	3
Description	4
Installation	6
Wiring.....	7
Initial configuration (wizard)	8
Operation	9
Configuration	22
Connectivity	28
Technical specifications.....	29
Accessories.....	30

AKO Electromecánica thanks and congratulates you for purchasing our product, in whose development and manufacture the most innovative technology has been used, as well as strict production and quality control processes.

Our commitment to satisfy our customers and our continuous efforts to improve every day can be seen in the various quality certifications we have obtained.

This is a high performance, high technology product. The operation and final performance of the equipment depend on proper planning, installation, configuration and commissioning. Read this manual carefully before installation, and always follow its instructions.

Only qualified personnel should install or perform technical assistance on this product.

This product is designed to be used in the applications described in the product manual. AKO Electromecánica gives no guarantee of its operation in any use not foreseen in the manual, and is not responsible for any damage resulting from improper use, configuration, installation or commissioning.

It is the responsibility of the installer and the customer to comply with and ensure others comply with all regulations applicable to installations incorporating our products. AKO Electromecánica is not responsible for any damage caused by non-compliance with regulations. Follow strictly the instructions given in this manual.

To maximise the service life of our equipment, these recommendations should be followed:

Do not expose electronic equipment to dust, dirt, water, rain, humidity, high temperatures, chemicals or corrosive substances of any sort.

Do not submit the equipment to blows or vibrations nor try to manipulate it differently from shown in the manual.

Never exceed the specifications and limitations indicated in the manual.



Always respect the specified ambient working and storage conditions.

During and after installation, avoid leaving loose, broken, unprotected or damaged wiring, since they might constitute a risk for the equipment and its users.

AKO Electromecánica reserves the right to make any non-metrology modification to the documentation or the equipment without previous notice

Versions and references

MODEL	DESCRIPTION	POWER SUPPLY	CIRCUIT BREAKER PROTECTION	CONTACTOR
AKO-16523	4 relay temperature controller	230 V~ ± 10%, 50 Hz ± 5%	No	No
AKO-16523-V		120 V ~ + 8% - 12%, 50 Hz ± 5%		
AKO-16523P	5 relay temperature controller	230 V~ ± 10%, 50 Hz ± 5%	Yes	Yes
AKO-16520P		120 V ~ + 8% - 12%, 50 Hz ± 5%		
AKO-16523D		230 V~ ± 10%, 50 Hz ± 5%		
AKO-16523L		230 V~ ± 10%, 50 Hz ± 5%	No	No
AKO-58500	CAMM Module	-	-	-

 AKO-16523 / AKO-16520 AKO-16523D / AKO-16523-V AKO-16523L	 AKO-16523P / AKO-16520P	 AKO-58500
--	--	--

Warnings



-If the equipment is used without adhering to the manufacturer's instructions, the device safety requirements could be compromised. Only probes supplied by AKO must be used for the unit to operate correctly.

- From -40 °C to +20 °C, if the NTC probe is extended to 1000 m with at least a 0.5 mm² cable, the maximum deviation will be 0.25 °C (cable for probe extension ref. **AKO-15586**. Earth the cable mesh at one end only).
- Only NTC type probes supplied by AKO must be used for the appliance to operate correctly.
- It must be installed in a place protected from vibrations, water and corrosive gases, where the ambient temperature does not exceed the value indicated in the technical data.
- For the reading to be correct, the probe must be used in a place without thermal influences apart from the temperature you want to measure or control.
- IP65 protection degree is only valid with the protection cover closed.
- The IP65 protection degree is only valid if the cables enter the device through a tube for electric conduits + gland with IP65 or above. The size of the glands must be suitable for the diameter of the tube used.
- Do not spray the unit directly with high-pressure hoses, as this could damage it.

Maintenance







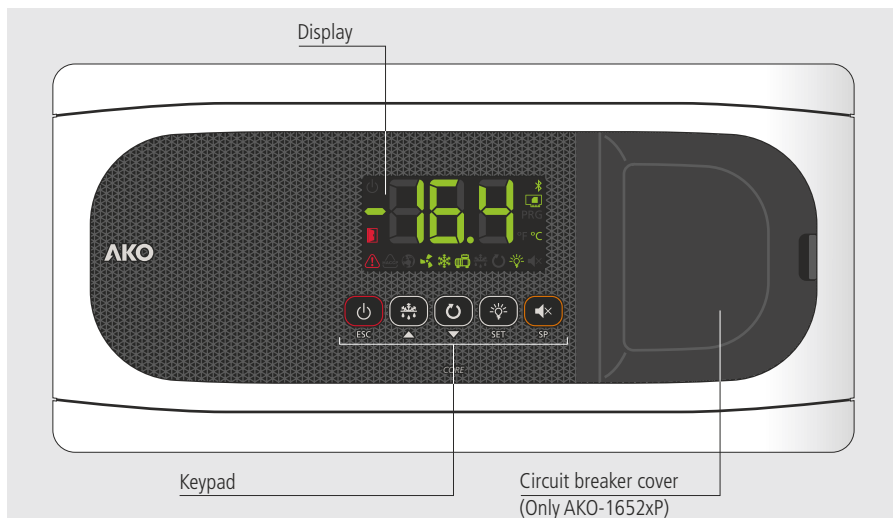





Clean the surface of the unit with a soft cloth, water and soap.

Do not use abrasive detergents, petrol, alcohol or solvents, as this might damage the unit.

Description



Indicators

- 
Constant: Stand-By Mode activated. Regulation is paused.
Flashing: Controlled stop process for the regulation in progress.
- 
Constant: Cold room door open.
Flashing: The door has been open for a longer time than defined in parameter A12.
- 
 There is an active alarm, but not an active HACCP alarm.
- 
Constant: HACCP alarm active.
Flashing: HACCP alarm recorded and unconfirmed. Press the 🔇 key to confirm an HACCP alarm.
- 
Constant: Evaporator fans active.
Flashing: The evaporator fans should be active but a delay is preventing this.
- 
Constant: The cold solenoid is active.
Flashing: The solenoid should be active but a delay or protection is preventing this.
- 
Constant: Compressor active.
Flashing: The compressor should be active but a delay or protection is preventing this.
- 
 Defrost relay active.
- 
 Continuous cycle mode active.
- 
 Cold room light active.
- 
 Alarm in progress muted.
- °F °C Temperature displayed in ° Fahrenheit / ° Centigrade.
- PRG Programming mode active.
- 
Constant: CAMM module in operation.
Flashing: Malfunction in CAMM module.
- 
 Bluetooth activated (only with CAMM module).

Keypad



ESC

Pressing it for 3 seconds activates/deactivates the Stand-By mode. In this mode, regulation is paused and the  icon is displayed.

In the programming menu, it exits the parameter without saving changes, returns to the previous level or exits programming.



▲

Pressing once without holding displays the temperature of probe S2 for 10 seconds (if it is enabled).

Pressing it for 3 seconds starts/stops the defrost.

In the programming menu, it allows scrolling through the different levels, or during the setting of a parameter, changing its value.



▼

Pressing it for 3 seconds activates/deactivates the continuous cycle mode.

In the programming menu, it allows scrolling through the different levels, or during the setting of a parameter, changing its value.



SET

Pressing once without holding activates/deactivates the cold room light.

Pressing it for 3 seconds accesses the condensed programming menu.

Pressing it for 6 seconds accesses the expanded programming menu.

In the programming menu, it accesses the level shown on the display or, during the setting of a parameter, accepts the new value.



SP

Pressing once without holding displays the current effective value of the Set Point, taking into consideration temporary modifications by other parameters (**C10** or **C12**).

When an alarm is in progress, pressing once without holding mutes the acoustic alarm.

Pressing for 3 seconds accesses the Set Point setting.



STAND-BY

To stop the controlled stop process and force the step to Stand-by, press the Stand-by key again for 3 seconds.

Installation

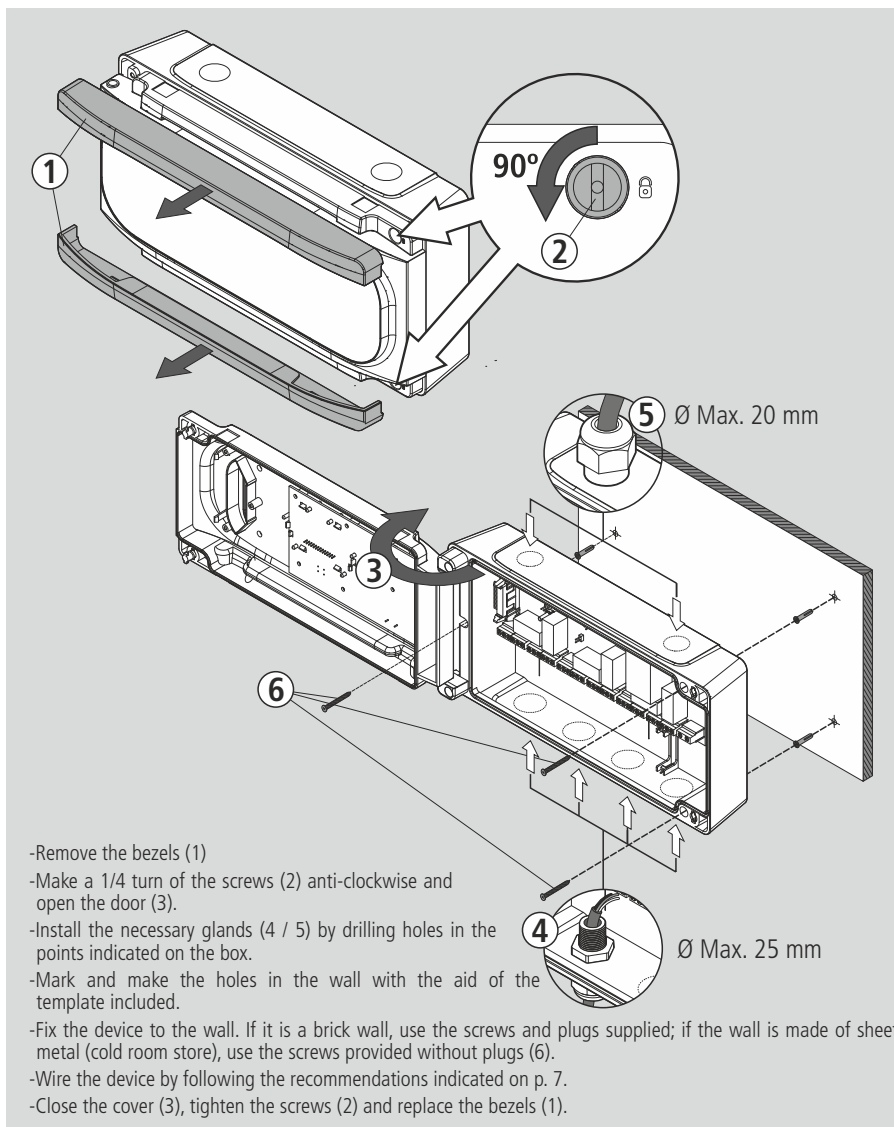

Wiring



Always disconnect the power supply to do the wiring.

The probes and their cables must **NEVER** be installed in a conduit together with power, control or power supply cables.

For disconnection, the power supply circuit must be equipped with at least a 2 A, 230 V switch, located near the device. The power supply cable shall be of the H05VV-F or NYM 1x16/3 type. The cross-section to be used will depend on the local regulations in force, but must never be less than 1.5 mm².

Cables for relay or contactor outputs must have a cross-section of 2.5 mm² and allow working temperatures equal to or over 70 °C and must be installed with as little bending as possible.

The 120/230 V~ wiring area must be kept clear of any other external element.

The wiring to be undertaken depends on the option selected in the initial configuration wizard (see p. 8). Use the appropriate diagram based on the option selected.

Check the available options on the diagram sheet included with your device.

The **AKO-16523D** model has a contactor which allows for the connection of three-phase defrost resistors, a three-phase compressor or three-phase fans, according to your installation's requirements. Check how to connect it on the diagram sheet included with your device.

IMPORTANT:

- The AUXILIARY relays are programmable, and their operation depends on the configuration.
- The function of the digital inputs depends on the configuration.
- The recommended currents and powers are the maximum working currents and powers.

Initial configuration (wizard)

The first time the unit receives the power supply, it will enter into ASSISTANT mode. The display will show the message *ini* flashing at 0.

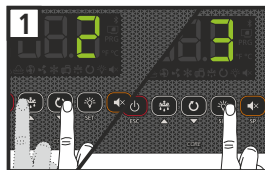

Step 1:

Select the most suitable Ini option based on the type of installation to be carried out and press **SET**. The available options will be shown in the following table:

Ini	Type of installation				Parameters										Diagram to be used
	Cold regulation	Pump Down	Defrost	Evaporator fans	Pd	o00	I00	I10	I11	I20	I21	d1	d7	F3	
0	Demo mode: it displays the temperature but does not regulate the temperature or activate relays.														
1	Solenoid	No	Electric	Yes	0	*	2	0	0	0	0	20	0	0	A
2	Solenoid + compressor	Yes	Electric	Yes	1	1	2	7	1	0	0	20	0	0	B
3	Solenoid + compressor	No	Electric	Yes	0	1	2	0	0	0	0	20	0	0	B
4	Solenoid	No	Air	Yes	0	*	1	0	0	0	0	20	1	1	A
5	Solenoid + compressor	Yes	Air	Yes	1	1	1	7	1	0	0	20	1	1	B
6	Solenoid + compressor	No	Air	Yes	0	1	1	0	0	0	0	20	1	1	B
7	Solenoid + compressor	Yes	Hot gas	Yes	1	1	2	7	1	9	1	5	2	0	C
8	Solenoid + compressor	No	Hot gas	Yes	0	1	2	0	0	9	1	5	2	0	C
9	Solenoid + compressor	Yes	Reversed cycle	Yes	1	1	2	7	1	0	0	5	3	0	D
10	Solenoid + compressor	No	Reversed cycle	Yes	0	1	2	0	0	0	0	5	3	0	D
11	Solenoid	No	Static	No	0	*	1	0	0	0	0	20	1	-	A
12	Solenoid + compressor	Yes	Static	No	1	1	1	7	1	0	0	20	1	-	B
13	Solenoid + compressor	No	Static	No	0	1	1	0	0	0	0	20	1	-	B

i If options 2, 5, 7, 9 or 12 are chosen, check the configuration of parameter I11 according to the pressure switch type used. (See diagram included with the device).

Step 2:

Use keys ▲ and ▼ to enter the desired Set Point value and press **SET**. The configuration wizard has finished. The unit will begin to regulate the temperature.

If this is not the first time you run the wizard, after completing the last step the display will show the message *dFP* (default parameters). You may choose between two options:

- 0: Only change the parameters which affect the wizard. The other parameters will remain the same.
- 1: All parameters return to their factory setting except those which have been modified by the wizard.

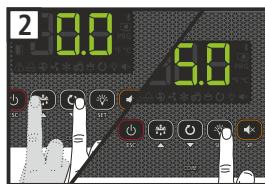















i The configuration wizard will not reactivate. To reactivate it, activate the Stand-By mode (by pressing the ⏻ key for 3 seconds) and wait until the unit completely halts regulation (the ⏻ indicator will light up permanently) and press in this order the following keys (one after the other, not at the same time) ▲, ▼ and **SET**.

! If the pump down function is active, a certain amount of time may elapse between starting the stand-by function and the controller stopping (see p. 11).

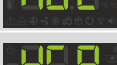
* o00=2 in AKO-16523 / 16520 / AKO-16523-V, o00=0 in AKO-16523P / 16520P / 16523D / 16523L.

Operation

Messages

MESSAGES	
	Pump down malfunction error (stop), the time configured in parameter C20 has been exceeded (see p. 11). Only displayed on screen.
	Pump down malfunction error (start-up), the time configured in parameter C19 has been exceeded (see p. 11). Only displayed on screen.
	Probe 1/2/3 failure (open circuit, crossed circuit or temperature outside the limits of the probe) (Equivalent limits in °F). Only E2 and E3: Damp evaporator probe (see p. 18). Activates the alarm relay and the audible alarm.
	Open door alarm. Only if the door remains open for a longer time than defined in parameter A12 (see p. 19). Activates the alarm relay and the audible alarm.
	Maximum temperature in control probe alarm. The temperature value programmed in A1 has been reached (see p. 18). Activates the alarm relay and the audible alarm.
	Minimum temperature in control probe alarm. The temperature value programmed in A2 has been reached (see p. 18). Activates the alarm relay and the audible alarm.
	External alarm activated (by digital input) (see p. 18). Activates the alarm relay and the audible alarm.
	Severe external alarm activated (by digital input) (see p. 18). Activates the alarm relay and the audible alarm.
	Alarm for defrost completed due to time-out. The time set in d1 has been exceeded (see p. 20). Activates the alarm relay and the audible alarm.
	HACCP alarm. The temperature has reached the value of parameter h1 during a longer period than established in h2 (see p. 19). Activates the alarm relay and the audible alarm.
	HACCP alarm due to a power supply failure. The temperature established in h1 has been reached, following a power supply failure (see p. 19). Activates the alarm relay and the audible alarm.
	Indicates that a defrost is being performed (see p. 15). Only displayed on screen.
	Password request. See parameters b10 and PAS (see p. 20). Only displayed on screen.
	Shown sequentially with the temperature: The controller is in demo mode, the configuration has not been made.

Cold regulation

Solenoid control (COOL Relay)

Cold production is regulated by means of opening / closing the solenoid valve.

When the temperature in probe S1 reaches the set point (SP) value plus the probe's differential (C1), the solenoid opens and causes the temperature to drop. Once the set point (SP) value is reached, the solenoid closes.

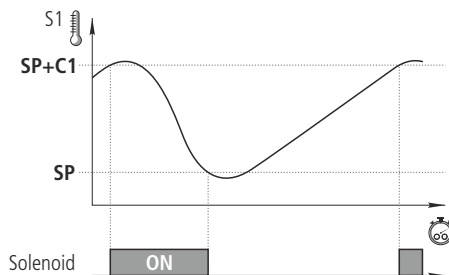

Compressor control (Relay AUX 1)

With Pump Down (Inl: 2, 5, 7, 9, 12)

Requires the connection of a low pressure switch in digital input 1.

When the temperature in probe S1 reaches the set point (SP) value plus the probe's differential (C1), the solenoid opens, causing the pressure in the evaporator to increase and, therefore, the low pressure switch deactivates and the compressor starts up.

Once the set point (SP) value is reached, the solenoid closes, causing the pressure in the evaporator to decrease, triggering the low pressure switch and stopping the compressor.

For further details of the process, see the next page.

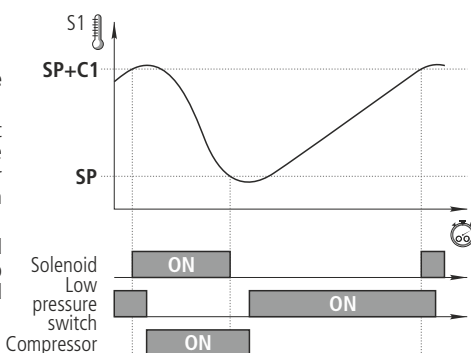

Without Pump Down (Inl: 3, 6, 8, 10, 13)

The compressor operates simultaneously with the solenoid valve, starting up when the latter opens and stopping when it closes.

Operation in the event of a fault in probe S1

If probe S1 fails (fault, disconnection, etc.), compressor behaviour will depend on parameter C6, with one of 3 options available:

C6=0: The compressor is stopped until probe S1 begins to operate again.

C6=1: The compressor is started-up until probe S1 begins to operate again

C6=2: The compressor operates in line with the average operation during the 24 hours prior to the error, taking into account the number of start-ups and stops and the average time in each state (stop-start). If 24 hours have not elapsed without a probe error, the device moves to C6=3 mode.

C6=3: C6=3: The compressor operates in line with the times programmed in C7 (ON) and C8 (OFF).

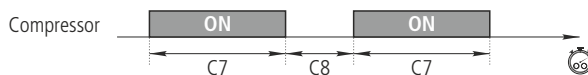

Pump down function

This function foresees problems in the compressor caused by movements of coolant, using a stop/start technique for the installation, controlled via the liquid solenoid, the low pressure switch and the compressor itself.

This function is only available for *Int* options 2, 5, 7, 9 and 12 and requires the connection of a low pressure switch in digital input 1. (**I10**=7)

STOP

When the temperature in probe S1 reaches the set point (**SP**) value, the COOL relay deactivates, closing the liquid solenoid.

Because the compressor continues to operate, pressure in the evaporator quickly drops. Upon reaching a given value, the low pressure switch activates, changing the status of digital input 1, which stops the compressor (relay AUX 1).

This manoeuvre isolates all of the coolant in the high-pressure line, far from the compressor crankcase, preventing serious faults upon start-up.

Should the low pressure switch fail, the controller stops the compressor once the safety interval defined in **C20** has elapsed, displaying the message "**Pd**" (an informative message that does not affect the unit's operation).

If **C20** time is 0 (default value), the compressor will not stop until the low pressure switch is activated, but it will display the "**Pd**" message after 15 minutes.

START

When the temperature in probe S1 reaches the set point value plus the differential (**SP+C1**), the COOL relay activates, opening the liquid solenoid. This increases the pressure in the evaporator, deactivating the low pressure switch, which turns the compressor on.

If, some time (determined by **C19**) after the liquid solenoid is opened (COOL relay set to ON), the low pressure switch does not deactivate, the controller will once again close the solenoid (COOL relay set to OFF) and the "**LP**" message will be displayed. This manoeuvre will be repeated every 2 minutes, indefinitely, until the pressure switch is deactivated and the installation reverts to its normal operation.

If **C19** time is 0 (default value), the solenoid will remain open until the low pressure switch deactivates, but it will display the "**LP**" message after 5 minutes.



STAND-BY

If the pump down function is active, a certain amount of time may elapse between starting the stand-by function and the controller stopping; this is because certain installation control phases cannot be interrupted.

To force the stop of the controller, press the Stand-by key again for 3 seconds.

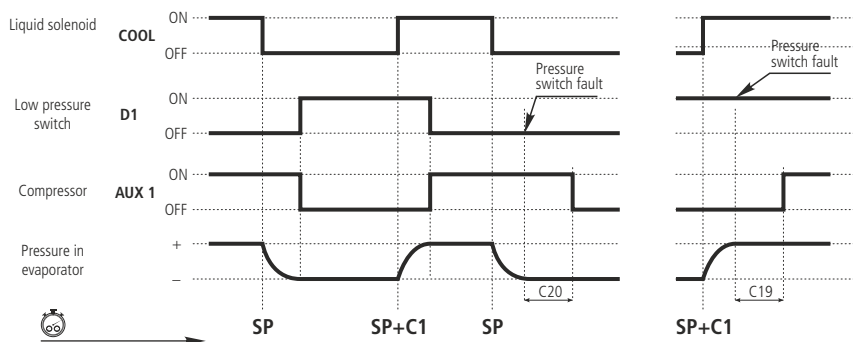

Continuous cycle mode

This is used to quickly cool the cold room stores before products are loaded and is activated by pressing the  key for 3 seconds.

Upon activating this mode, the compressor begins to operate until the temperature in probe S1 reaches the set point value, minus the variation indicated in parameter **C10**. The value of **C10** is always negative, unless it is 0.

The unit will immediately return to normal operation.

Should it not be possible to reach this point, the device will return to normal operation once the time configured in **C9** has elapsed, or by pressing the  key again for 5 seconds.

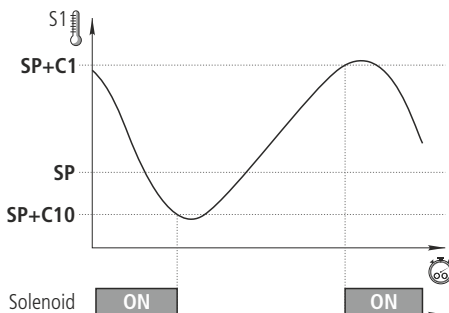

Set Point change mode

This allows for quick alternation between two working temperatures in the cold room store, modifying the Set Point in line with the value indicated in parameter **C12**. The aforementioned value may be negative or positive, which allows for the Set Point to be reduced or increased. If it is configured in 0, the mode is disabled.

It is activated in three possible ways:

- By means of an external switch connected to one of the digital inputs. The digital input should be configured as "Set Point change (**I10** or **I20**=4). Activation through this method cancels any other activation and can only be deactivated using the same method.
- By means of the AKONet application. This requires the device to be connected to a Modbus network (see p. 28).
- By means of the CAMM module and the AKO CAMM tool application.

EXAMPLE:

Calibration of probe 1

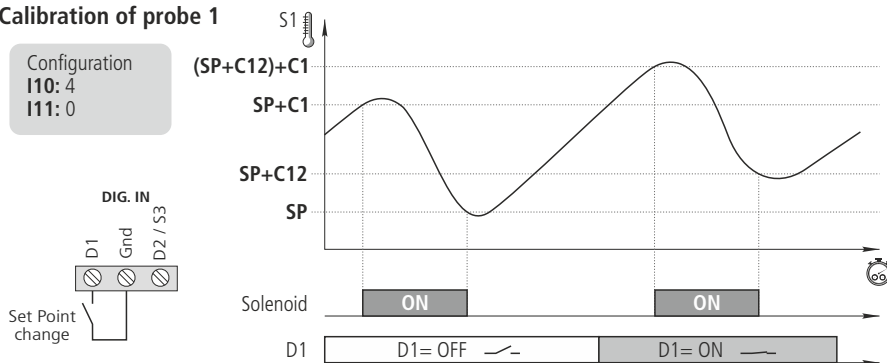

Parameter **C0** allows for correction of the temperature detected by probe 1; this is particularly useful when the probe cannot be located in the ideal place.

Set Point locking

Parameters **C2** and **C3** allow for an upper and lower limit to be established for the set point (**SP**), to protect the product or installation from Set Point manipulation.

Compressor protection timing

Parameter **C4** allows for selection of the type of timing to be applied to protect the compressor. These delays prevent continuous compressor starts and stops.

These timings affect the COOL and AUX 1 relays (if **o00**=1)

OFF-ON (C4=0): Minimum time in OFF mode before each start-up.

OFF-ON / ON-OFF (C4=1): Minimum time in ON and OFF mode for each cycle.

The delay time is defined by means of parameter **C5**; if **C5**=0, timing is disabled.

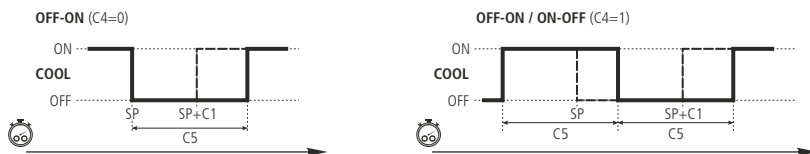

Door management

Door management allows for the installation's behaviour to be controlled, should the cold room door open through parameters **C22** and **C23**.

Parameter **C22** defines whether cold production should be stopped if the door opens. If **C22**=1, when the door opens, the fans stop and, 15 seconds later, the solenoid closes (COOL relay).

Parameter **C23** defines the maximum time, in minutes, that the installation can remain without producing cold whilst the door is open. If **C23**=0, cold is not produced with the door open.

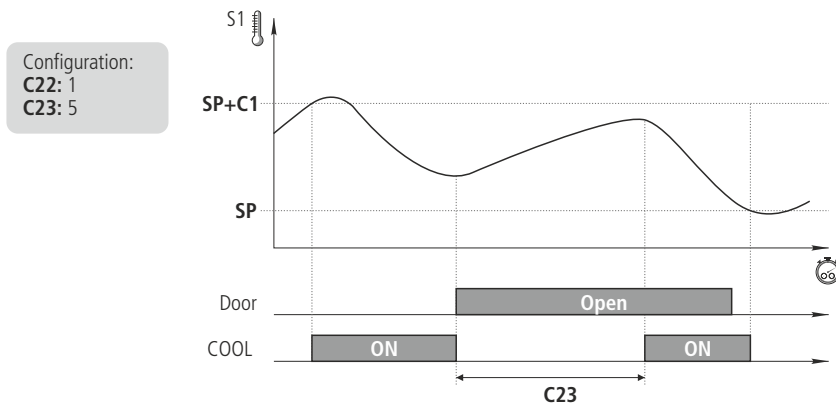

Management of door frame resistor (only devices with 5 relays)

If the Set Point is equal to or below -4°C and the relay AUX 2 has been configured as "door frame resistor" (**o10**=4), the resistor is activated (relay ON) when the temperature of the cold room drops below -3°C , and is deactivated (relay OFF) when 0°C is reached.

Defrost

Types of defrost

There are 5 possible defrost types, depending on the option selected in the wizard (InI):

Electric (InI=1, 2 and 3) (d7=0)

Defrost is performed through electrical resistors, supplying the evaporator with heat. The operation of fans in this mode depends on parameter **F3**; the compressor and solenoid are stopped.

By air (InI=4, 5 and 6) (d7=1)

Usually used in positive cold rooms (> 3°C), since the inside temperature of the cold room is sufficient to melt evaporator ice. By default, the fans are activated so that air may circulate through the evaporator; to stop them, change parameter F3 to 0. The compressor and solenoid are stopped.

Static (InI=11, 12 and 13)

In this type of installation, there are no evaporator fans and defrost is performed by stopping cold production.

Hot gas (InI=7 and 8) (d7=2)

The hot gas from compressor discharge is used to melt evaporator ice and, to this end, two valves are necessary: one at the condenser input (A) (SSV relay) and another between the compressor output and the evaporator input (B) (DEF relay).

During the process, the liquid solenoid valve (C) and the condenser input valve are closed and the evaporator input valve is opened, forcing hot gas to pass through the latter and melting the ice.

Optionally, a high pressure switch (D) can be added to control the solenoid valve (digital input D2, **I20=9**) during the defrost process using hot gas. If the pressure decreases, the solenoid opens to allow liquid into the tank; when the pressure rises again, the solenoid closes.

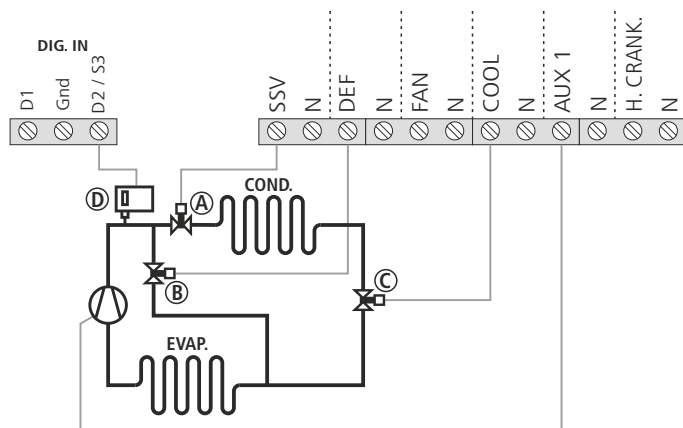

Reversed cycle (InI=9 y 10) (d7=3)

A 4-way valve is used to invert the installation cycle, using the evaporator as a condenser to melt the ice formed. The process begins by stopping cold production (if it is active). If Pump Down is active, defrost begins once the manoeuvre is complete.

Next, the 4-way valve is activated (DEF relay ON), alongside the solenoid (COOL relay ON) and the compressor (AUX 1 ON), and the defrost process begins. D1 time begins to be counted after the COOL relay is activated.

When defrost is complete, the manoeuvre can be stopped in two possible ways:

- Pump down active (InI=9): The solenoid closes (COOL relay OFF) and the 4-way valve returns to its initial position (DEF relay OFF) whilst the compressor continues to operate (AUX 1 relay ON), until the low pressure switch activates, stopping the compressor (AUX 1 relay OFF), starting the drip time.
- Without Pump Down (InI=10): The solenoid closes (COOL relay OFF) and the 4-way valve returns to its initial position (DEF relay OFF) and the compressor stops (AUX 1 relay OFF), starting the drip time.

Defrost control

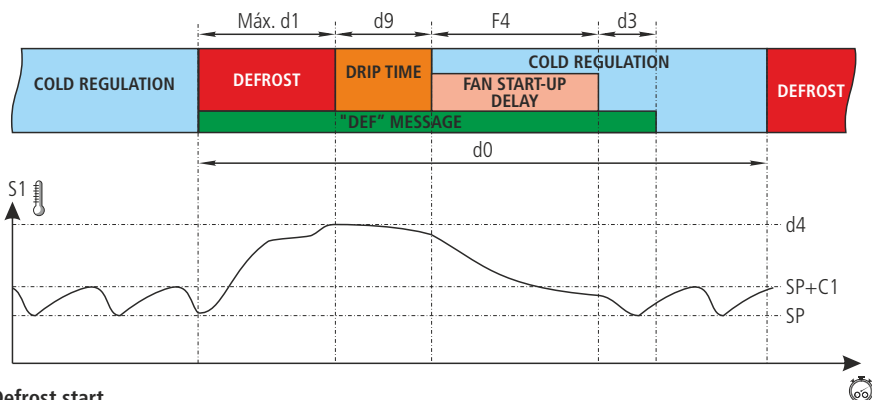

Defrost start

Defrost will start if:

- The time programmed in parameter **d0** has elapsed since the start of the last defrost.
- We press the **🔑** key for 3 seconds.
- By means of an external push-button (**I10 / I11=5**).
- Through the app or through AKONet.

Defrost completion

Defrost will complete if:

- The temperature programmed in parameter **d4** has been reached in probe 2. This requires a 2nd probe (**I00=2**) to be available, located in the evaporator.
- The time configured in parameter **d1** has elapsed (maximum defrost duration).
- We press the **🔑** key for 5 seconds.
- By means of an external push-button (**I10 / I11=5**).
- Through the app or through AKONet.

Drip time

This is established through parameter **d9** and sets the time added at the end of defrost to allow for the removal of surplus water from melted evaporator ice, during which there is no cold regulation.

Fan start-up delay

This is established through parameter **F4** and allows for the possible drops left in the evaporator to freeze before the fans activate, preventing them from being projected into the cold room. It also prevents heat being supplied to the cold room due to defrost in the evaporator.



If defrost is cancelled before 1 minute has elapsed, the drip time (**d9**) is not applied and the fans are activated without taking into account the start-up delay (**F4**).

If defrost is by air or is static, the drip time (**d9**) and fan start-up delay (**F4**) are deactivated.

Message displayed during defrost

This is established using parameter **d2**, and you can choose between displaying the real temperature captured by probe 1 (**d2=0**), showing the temperature captured by probe 1 at the start of the defrost (**d2=1**), or displaying the dEF (**d2=2**) message. Parameter **d3** defines the time during which the aforementioned message will be displayed once the drip time (**d9**) and fan stop time (**F4**) are complete.

Remote defrost

This function allows defrost of the unit to be activated using an external button, connecting it to one of the digital inputs that must be configured as remote defrost (**I10** or **I20=5**).

Defrost locking

This prevents defrost starting at unusual points by means of an external switch, which may be useful for ensuring that the installation's load does not excessively increase, exceeding the permitted limits.

The external switch must be connected to one of the digital inputs, which should be configured as "Defrost locking" (**I10** or **I20=6**).

Defrost of a second evaporator (only devices with 5 relays)

This function allows for defrost to be controlled in a second evaporator, provided that defrost is by electric heat, by air or is static. The same type of defrost should be used for the first and second evaporators.

This requires configuration of input 2 as a 2nd evaporator probe (**I20=8**). In the event of an error in the 2nd evaporator probe, defrost completes once the time defined in **d1** has elapsed.

Electric defrosting

This requires configuration of relay AUX 2 as 2nd evaporator defrost (**o10=5**).

Defrost begins simultaneously in both evaporators. When the probe of evaporator 1 reaches the temperature defined in **d4**, the DEF relay deactivates, completing defrost of evaporator 1. Defrost of evaporator 2 is completed when the evaporator 2 probe reaches the temperature defined in **d4**. Drip time begins when both defrosts are complete.

Defrost by air

The fans of both evaporators are connected in parallel to the FAN relay.

Defrost begins simultaneously in both evaporators and does not complete until both probes reach the temperature defined in **d4**. Drip time subsequently begins.

Static defrost

Defrost begins simultaneously in both evaporators and does not complete until both probes reach the temperature defined in **d4**. Drip time subsequently begins.

Other parameters

Using parameter **d5**, you can configure whether the unit performs a defrost (**d5=1**) or not (**d5=0**) when it receives power (first start-up or after a power supply failure). Should the option YES (**d5=1**) be selected, defrost will begin once the delay time defined in **d6** has elapsed.

Using parameter **d8**, we define the time tally established in **d0**, choosing between total time elapsed (**d8=0**) or the sum of compressor operation time (**d8=1**).



REMARK: If parameter **d1** is configured to 0, no defrosts are performed.

Fan control

Fans are controlled through probe 2 (evaporator) and parameters **F0** (stop temperature) and **F1** (probe differential).

If probe 2 is not connected or an error in the probe (**E2**) is detected, the fans continuously operate without taking into account parameters **F0** and **F1**, but taking the remaining parameters (**F2** to **F4**) into account.

Using parameter **F2**, the status of the fans during compressor stops is defined.

Using parameter **F3**, the status of the fans during defrost is defined.

Parameter **F4** defines the fan start-up delay time after defrost (see p. 15).

Parameter **C22** defines whether fans stop when the door is opened.

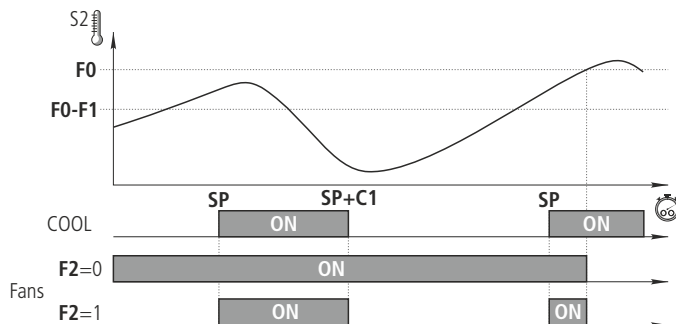

Alarms

The device warns the user through an on-screen message, activation of a relay (only 5-relay devices if **o10**=1 or 4-relay devices if **o00**=4) and a sound alarm when the criteria programmed in the parameters are met.

Maximum / minimum temperature alarm

It shows the message "**RH**" or "**RL**" when the temperature in probe 1 reaches the value configured in parameters **A1** (maximum temperature) and **A2** (minimum temperature).



This value may be:

- Absolute (**A0**=1): The temperature at which the alarm should activate must be indicated in **A1/A2**.
- Relative to the SP (**A0**=0): The increase or decrease in the number of degrees necessary for the alarm to activate, in relation to the set point, must be indicated in **A1/A2**. This option enables us to change the set point without having to reset the maximum and minimum alarms.

Parameter **A10** establishes the differential of both parameters (Hysteresis).



Example

We configure the following parameters in a controller: **SP**=2, **A1**=10, **A10**=2

- If **A0**=0 (Relative to the SP), the maximum temperature alarm will activate when 12 degrees are reached in probe 1, and will deactivate when 10 degrees are reached.
- If **A0**=1 (Absolute), the maximum temperature alarm will activate when 10 degrees are reached in probe 1, and will deactivate when 8 degrees are reached.

External alarm / severe external alarm

The message **ER** (External alarm) or **SEER** (Severe external alarm) is displayed when the digital input configured as external alarm or severe external alarm is activated.



The severe external alarm also deactivates all the loads and, therefore, temperature regulation stops. When this alarm disappears, the device returns to its normal operation.

At least one of the digital inputs must be configured as an external alarm (**I10** or **I20**=2) or as a severe external alarm (**I10** or **I20**=3).

Probe error alarm

If one of the enabled probes is crossed, in open circuit or out of range, the message **E1**, **E2** or **E3** will be shown, depending on whether probe S1, S2 or S3 is involved.



Evaporator probe error alarm due to moisture ingress

If, at the start of defrost, the temperature in probe S2 is 20°C higher than the temperature in probe S1, the defrost ignores probe S2 and completes due to time-out.

The display shows the message **E2**, activates the alarm relay and sound alarm.



The alarm can be silenced, but the  alarm icon will not disappear until:

- The controller is switched off and then on again.
- Defrost without error is started in probe S2.

If the 2nd evaporator probe (**I20**=8) has been enabled, it will behave in the same way, but displaying the message **E3**.

Open door alarm

The door has been open for a longer time than defined in parameter **A12**, the open door alarm is activated.

In order to detect the open door, configuration is required of one of the digital inputs as "door contact" (**I10** or **I20=1**).

Activates alarm relay and sound alarm.



HACCP alarm

The alarm is activated should situations be detected which could endanger the integrity of the products stored in the cold room.

If the temperature of the cold room is higher than that defined in parameter **h1** for a length of time exceeding that defined in parameter **h2**, the alarm activates, displaying the message **hCP** on screen.

Upon pressing the mute key, the sound alarm switches off, but the alarm remains.

Once the temperature drops below parameter **h1**, if the mute key has been pressed, the alarm disappears. If the mute key has not been pressed, the audible alarm deactivates but the HACCP indicator remains in flashing mode, indicating that a non-confirmed HACCP alarm has occurred.

Press the mute key to confirm an HACCP alarm.

If, during a power failure, a HACCP alarm occurs, when the power supply returns, the HACCP alarm is activated and the display shows the messages **hCP** and **PF** (power failure) alternately.



Alarm delays

These delays prevent certain alarms from being shown, to allow the installation to recover its normal operation after certain events.

- Delays in start-up (A3): This delays the activation of the temperature alarms upon receiving power (at start-up or after a power supply failure) or when exiting Stand-by mode. This allows for the installation to start up avoiding alarms.
- Delay after a defrost (A4): This delays the activation of the temperature alarms when a defrost completes.
- Delay to minimum and maximum temperature alarm (A5): This delays the activation of the maximum (A1) and minimum (A2) temperature alarms, from when the temperature in probe 1 reaches the programmed value.
- Delay to activation of external alarm (A6): This delays the activation of the external alarm, from when the digital input becomes active.
- Delay to deactivation of external alarm (A7): This delays the deactivation of the external alarm, from when the digital input becomes active.
- Delay to open door alarm (A12): This delays the activation of the alarm upon detecting that the door is open.

Configuration of alarm relay

Should any relay have been configured as an alarm relay, parameter **A9** allows for the relay status to be defined when an alarm is triggered:

A9=0 Relay active (ON) in the event of an alarm (OFF without alarm)

A9=1 Relay inactive (OFF) in the event of an alarm (ON without alarm)

Alerts

The device alerts the user through an on-screen message when an event occurs which requires his/her attention. However, it does not activate the sound alarm or the alarm relay (if active).

Defrost finished by time alarm

The message **AdE** is displayed when a defrost has completed due to time-out, if parameter **A8=1**.



Pump down malfunction error (stop)

The message **Pd** is displayed if a malfunction is detected when the installation is stopped using the pump down manoeuvre. (See p. 11).



Pump down malfunction error (start-up)

Displays the **LP** message if a malfunction is detected when the installation is started up using the pump down manoeuvre. (See p. 11).



Light control

Relay AUX 1 or AUX 2 must be configured as "Light" (**o00** or **o10=2**).

Switching the lights on or off is controlled using:

The  push-button: One press switches the lights on or off.

The cold room door: When the door is opened, the lights remain on for the time defined by parameter **b01**. If the value is 0, when the door closes the lights go out. (One of the digital inputs must be configured as door contact (**I10** or **I20=1**).

The control even occurs with the equipment in Stand-by.

Password

It allows protecting the configuration of the unit using a 2 digit code (from 01 to 99). If it is active a code is requested when you try to access the programming menu. This menu cannot be accessed if a wrong value is entered. The code is set via the **PAS** parameter.

Parameter **b10** defines the operation of this code.



Remote Stand-by mode

This allows activating Stand-by mode using a switch connected to one of the digital inputs. Said digital input must be set to Stand-by remote activation (**I10=8** or **I20=12**).

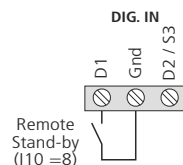

Operation of the auxiliary relays

Depending on the controller model, it may have 1 or 2 auxiliary relays. The function of these relays is configurable through the parameters menu.

AUX 1 relay

- **Deactivated (o00=0)**: It does not carry out any function.
- **Compressors / crankcase resistor (o00=1)**: Controls compressor operation. When the compressor is not in operation, it powers the crankcase resistor. This function can only be selected via the initial wizard (*ini*).
- **Light (o00=2)**: This regulates the operation of cold room light (see p. 20).
- **Virtual control (o00=3)**: The relay can be remotely activated and deactivated by means of AKONet software.
- **Alarm (o00=4)**: This activates the relay every time that an alarm occurs (Only in devices with 4 relays) (see p. 19).

AUX 2 relay (only devices with 5 relays)

- **Deactivated (o10=0)**: It does not carry out any function.
- **Alarm (o10=1)**: This activates the relay every time that an alarm occurs (see p. 19).
- **Light (o10=2)**: This regulates the operation of cold room light (see p. 20).
- **Virtual control (o10=3)**: The relay can be remotely activated and deactivated by means of AKONet software.
- **Door frame resistor (o10=4)**: This controls the operation of the cold room's door frame resistor (see p.13).
- **Defrost 2° evaporator (o10=5)**: This controls the defrost resistors of a second evaporator (see p. 16).
- **Same as solenoid status (o10=6)**: Imitates solenoid status: active if the solenoid is in ON mode, inactive if the solenoid is in OFF mode.
- **Same as unit status (o10=7)**: Indicates the unit's status: active if the unit is in ON mode, inactive if the unit is in Stand-by mode.

Configuration

Condensed programming menu

This allows for the most-used parameters to be quickly configured. Press the **SET** key for 3 seconds to access it.

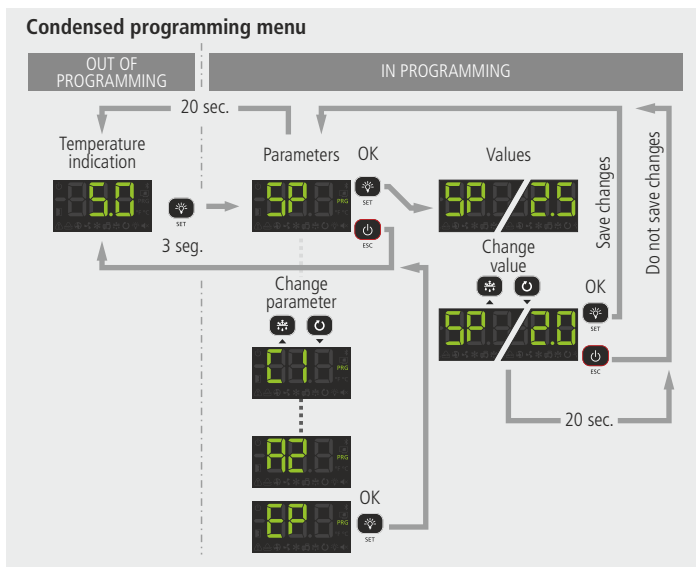

Parameters

Level 2	Description	Values	Min.	Def.	Max.
SP	Temperature setting (Set Point)	°C/°F	-50	0.0	99
E I	Probe 1 differential (Hysteresis)	°C/°F	0.1	2.0	20.0
dB	Defrost frequency (Time between 2 starts)	H.	0	6	96
d I	Maximum defrost duration (0=defrost deactivated)	Min.	0	*	255
d4	Final defrost temperature (by probe) (If I00 ≠ 1)	°C/°F	-50	8.0	C2
F3	Status of the fans during the defrost 0=Shut down; 1=Running		0	0	1
R I	Alarm for maximum in probe 1 (It should be higher than the SP)	°C/°F	A2	99	99
R2	Alarm for minimum in probe 1 (It should be lower than the SP)	°C/°F	-50	-50	A1

* According to wizard.

Extended programming menu

Use the extended programming menu to configure all of the unit's parameters in order to adapt it to your installation requirements. Press the **SET** key for 6 seconds to access it.

i **IMPORTANT:** If the password function has been configured as a keypad lock (**b10=2**), or as an access to parameters block (**b10=1**), you will be requested to enter the password programmed in **PAS** when attempting to access either of the two functions. If the entered password is not correct, the unit will go back to showing the temperature.

i **IMPORTANT:** Certain parameters or menus may not be visible depending on the configuration of the rest of the parameters.

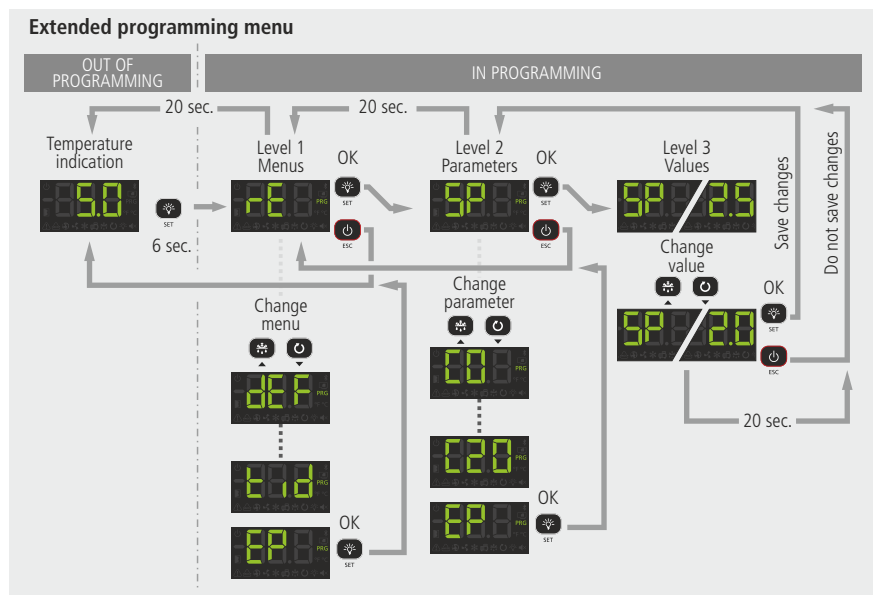

Parameters

Level 1	Level 2	Description	Values	Min.	Def.	Max.	
rE	SP	Temperature setting (Set Point)	°C/°F	-50	0.0	99	
	C0	Probe 1 calibration (Offset)	°C/°F	-20.0	0.0	20.0	
	C1	Probe 1 differential (Hysteresis)	°C/°F	0.1	2.0	20.0	
	C2	Set Point top locking (it cannot be set above this value)	°C/°F	C3	99	99	
	C3	Set Point bottom locking (it cannot be set below this value)	°C/°F	-50	-50	C2	
	C4	Type of delay for the protection of the compressor: 0=Minimum time of compressor in OFF 1=Minimum time of compressor in OFF and in ON in each cycle			0	0	1
	C5	Protection delay time (Value of the option selected in parameter C4)	Min.	0	0	120	
	C6	COOL relay status with fault in probe 1: 0=OFF; 1=ON; 2=Average according to last 24h prior to probe error 3=ON-OFF according to prog. C7 and C8		0	2	3	
	C7	Relay time in ON in the event of probe 1 failure (If C7=0 and C8≠0, the relay will always be disconnected in OFF)	Min.	0	10	120	
	C8	Relay time in OFF in the event of probe 1 failure (If C8=0 and C7≠0, the relay will always be connected in ON)	Min.	0	5	120	
	C9	Maximum duration of the continuous cycle mode. (0=deactivated)	H.	0	0	48	
	C10	Variation of the Set Point (SP) in continuous cycle mode. When it reaches this point (SP+C10), it reverts to the normal mode. (SP+C10 ≥ C3). The value of this parameter is always negative, unless it is 0. (0=OFF)	°C/°F	0	-50	C3-SP	
	C12	Variation of the Set Point (SP) when the change Set Point function is active. (SP+C12 ≤ C2) (0= deactivated)	°C/°F	C3-SP	0.0	C2-SP	
	C19	Maximum start time from Pump Down (Values between 1 and 9 seconds will not be accepted) (0=deactivated)	Sec.	0	0	120	
	C20	Maximum time for pump down (0= deactivated)	Min.	0	0	15	
	C21	Probe to be displayed 0=All probes (sequential) 1=Probe 1 (Chamber) 2=Probe 2 (Evaporator) 3=Probe 3 (According to I20)		0	1	3	
	C22	Stop fans and compressor on opening door 0=No 1=Yes		0	0	1	
	C23	Start-up delay for fans and compressor with door open	Min.	0	0	999	
	C27	Probe 3 calibration (Offset)	°C/°F	-20.0	0.0	20.0	
	EP	Exit to level 1					

Level 1	Level 2	Description	Values	Min.	Def.	Max.
dEF	d0	Defrost frequency (Time between 2 starts)	H.	0	6	96
	d1	Maximum defrost duration (0 =defrost deactivated)	Min.	0	*	255
	d2	Type of message during the defrost: 0 =Displays the real temperature; 1 =Displays the temperature at the start of the defrost; 2 =Displays the dEF message		0	2	2
	d3	Maximum duration of the message (Time added at the end of the defrost process)	Min.	0	5	255
	d4	Final defrost temperature (by probe) (If I00 ≠ 1)	°C/°F	-50	8.0	C2
	d5	Defrost on connecting the unit: 0 =NO First defrost according to d0; 1 =YES, First defrost according to d6		0	0	1
	d6	Delay of the defrost start on connecting the unit	Min.	0	0	255
	d7	Type of defrost: 0 =Resistors; 1 =Air/fans 2 =Hot gas; 3 =Reversal of cycle		0	*	3
	d8	Count of time between defrost periods: 0 =Total real time 1 =Sum of compressor connected time		0	0	1
	d9	Drip time when completing defrost (Shutdown of compressor and fans)	Min.	0	1	255
EP	Exit to level 1					

Level 1	Level 2	Description	Values	Min.	Def.	Max.
FRn	F0	Shutdown temperature of fans	°C/°F	-50	45	50
	F1	Probe 2 differential if fans are shut down	°C/°F	0.1	2.0	20.0
	F2	Shut down fans when the compressor shuts down 0 =No 1 =Yes		0	0	1
	F3	Status of the fans during the defrost 0 =Shut down; 1 =Running		0	0	1
	F4	Delay of start-up after defrost (If F3=0) It will only actuate if it is higher than d9	Min.	0	2	99
EP	Exit to level 1					

* According to wizard.

➤ It can only be modified using the configuration wizard (Inl).

Level 1	Level 2	Alarms				
		Description	Values	Min.	Def.	Max.
RL	R0	Configuration of the temperature alarms 0 =Relative to SP 1 =Absolute		0	1	1
	R1	Alarm for maximum in probe 1 (It should be higher than the SP)	°C/°F	A2	99	99
	R2	Alarm for minimum in probe 1 (It should be lower than the SP)	°C/°F	-50	-50	A1
	R3	Delay of temperature alarms in the start-up	Min.	0	0	120
	R4	Delay of temperature alarms from the end of a defrost	Min.	0	0	99
	R5	Delay of temperature alarms from when the A1 or A2 value is reached		0	30	99
	R6	Delay of the external alarm/Severe external alarm on receiving a signal in digital input (I10 or I20 =2 or 3)	Min.	0	0	120
	R7	Delay of external alarm deactivation/Severe external alarm deactivation when the signal in digital input disappears (I10 or I20 =2 or 3)	Min.	0	0	120
	R8	Show warning if the defrost ends for maximum time 0 =No 1 =Yes		0	0	1
	R9	Relay alarm polarity 0 = Relay ON in alarm (OFF without alarm); 1 = Relay OFF in alarm (ON without alarm)		0	0	1
	R10	Differential of temperature alarms (A1 and A2)	°C/°F	0.1	1.0	20.0
	R12	Delay of open door alarm (If I10 or I20 =1)	Min.	0	10	120
	EP	Exit to level 1				

Level 1	Level 2	Basic configuration				
		Description	Values	Min.	Def.	Max.
bcn	b00	Delay of all functions on receiving power supply	Min.	0	0	255
	b01	Cold room light timing	Min.	0	0	999
	b10	Function of password 0 =Inactive 1 =Block access to parameters 2 =Block keypad		0	0	2
	PR5	Access code (Password)		0	0	99
	b20	MODBUS address		1	1	247
	b21	Communication speed: 0 =9600 bps 1 =19200 bps 2 =38400 bps 3 =57600 bps	bps	0	0	3
	b22	Acoustic alarm enabled 0 = No 1 =Yes		0	1	1
	Unit	Work units 0 =°C 1 =°F		0	0	1
	EP	Exit to level 1				

* According to wizard.

Level 1	Level 2	Description	Values	Min.	Def.	Max.
h	h0	Connected probes 1=Probe 1 (Cold room) 2=Probe 1 (Cold room) + Probe 2 (Evaporator)		1	2	2
	h1	Configuration of digital input 1 0=Deactivated 1=Door contact 2=External alarm 3=Severe external alarm 4=Change of SP 5=Remote defrost 6=Defrost block 7=Low pressure switch 8=Remote Stand-by		0	*	8
	h11	Polarity of the digital input 1 0=Activates on closing contact; 1=Activates on opening contact		0	*	1
	h2	Configuration of digital input 2 0=Deactivated 1=Door contact 2=External alarm 3=Severe external alarm 4=Change of SP 5=Remote defrost 6=Defrost block 7=Register probe 8=Probe 2° evaporator ** 9=High pressure switch for Hot Gas 10=Remote Stand-by		0	0	10
	h21	Polarity of the digital input 2 0=Activates on closing contact; 1=Activates on opening contact		0	0	1
	o00	Configuration of relay AUX1 0=Deactivated 1=Compressor/Resistor sump 2=Light 3=Virtual control 4=Alarm (AKO-16523 / 16523-V / 16520 Only)		0	*	4
	o10	Configuration of relay AUX2 (Not available in AKO-16523 / 16523-V / 16520) 0=Deactivated 1=Alarm 2=Light 3=Virtual control 4=Door frame resistance 5=Defrost 2° evaporator 6=Same as solenoid status 7=Same as unit status		0	2	7
EP	Exit to level 1					

Level 1	Level 2	Description	Values	Min.	Def.	Max.
HCP	h1	Maximum temperature of HACCP alarm	°C/°F	-50	99	99
	h2	Maximum permitted time for activation of the HACCP alarm (0=Disabled)	H.	0	0	255
	EP	Exit to level 1				

Level 1	Level 2	Description	Values	Min.	Def.	Max.
t, d	ini	Option chosen in the configuration wizard				
	pd	Pump down active? 0=No 1=Yes				
	pu	Programme version				
	pr	Programme revision				
	bu	Bootloader version				
	br	Bootloader revision				
	prr	Parameter map revision				
	EP	Exit to level 1				

* According to wizard.

** Option not available in AKO-16523 / 16523-V / 16520

➤ It can only be modified using the configuration wizard (Inl).

Connectivity

The controllers are equipped with a port for connection of RS485 (MODBUS) data, which allows for remote management of these using an **AKO-5012** web-server.

The MODBUS address is factory-set and is indicated on the rating plate located on the left side of the controller. This address must be different for each unit within the same network. The address can be changed using parameter **b20**. Once modified, the old address indicated on the plate will not be valid.

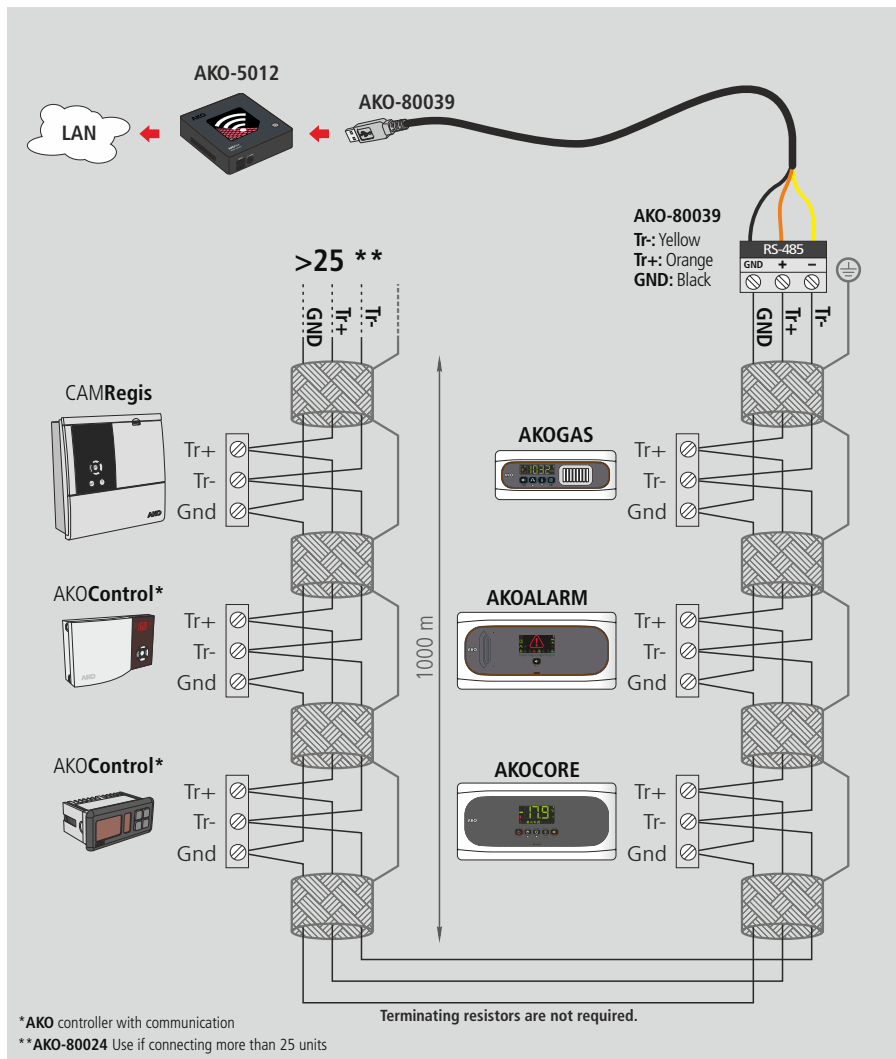

Technical specifications

Power supply	AKO-16523 / 16523P / 16523D / 16523-V / 16523L	230 V~ ± 10%, 50 Hz ± 5%
	AKO-16520 / 16520P	120 V ~ + 8% - 12%, 50 Hz ± 5%
Maximum input power in the operation		6.3 VA
Maximum nominal current		15 A
Relay SSV / DEFROST - SPDT - 20 A	NO	(EN60730-1: 15 (15) A 250 V~)
	NC	(EN60730-1: 15 (13) A 250 V~)
Relay FAN - SPST - 16 A		(EN60730-1: 12 (9) A 250 V~)
Relay COOL - SPST - 16 A		(EN60730-1: 12 (9) A 250 V~)
Relay AUX 1 / H.CRANK. - SPDT - 20 A	NO	(EN60730-1: 15 (15) A 250 V~)
	NC	(EN60730-1: 15 (13) A 250 V~)
Relay AUX 2 - SPDT - 16 A	NO	(EN60730-1: 12 (9) A 250 V~)
	NC	(EN60730-1: 10 (8) A 250 V~)
Contactor - 20A (AKO-16523D)	AC1	20 A 400 V~ (III+N)
	AC3	9 A 400 V~ (III+N)
No. of relay operations		EN60730-1:100.000 operations
Probe temperature range		-50.0 °C to 99.9 °C
Resolution, setting and differential		±0.1 °C
Thermometric precision		±1 °C
Loading tolerance of the NTC probe at 25 °C		±0.4 °C
Input for NTC probe		AKO-14901
Working ambient temperature	AKO-16523 / 16520 / 16523-V	-10 °C a 50 °C
	AKO-16523P 16520P	-10 °C a 45 °C
	AKO-16523D / 16523D	-10 °C a 40 °C
Storage ambient temperature		-30 °C to 60 °C
Protection degree		IP 65
Installation category		II s/ EN 60730-1
Pollution degree		II s/ EN 60730-1
Control device classification: Built-in assembly, with Type 1.B automatic operation action feature, for use in clean situations, logical support (Software) class A and continuous operation. Degree of contamination 2 acc. to UNE-EN 60730-1.		
Double isolation between power supply, secondary circuit and relay output.		
Temperature during ball-pressure test	Accessible parts	75 °C
	Parts which position active elements	125 °C
Current of radio jamming suppression tests		270 mA
Voltage and current as per EMC tests:		
	AKO-16520 / 16520P / 16523-V	105 V, 36 mA
	AKO-16523 / 16523P / 16523D / 16523D	207 V, 17 mA
Type of assembly		Fixed internal
MODBUS address		Shown on label
Dimensions		290 mm (W) x 141 mm (H) x 84.4 mm (D)
Internal buzzer		

Accessories

AKO-58500 CAMM Module

Together with the application for mobile devices, this module provides the unit with multiple functionalities:

- Data logging
- Logging of configuration changes
- Remote configuration
- Clock functions in real time
- Activity summaries
- Logging of events and alerts
- Remote control of functions

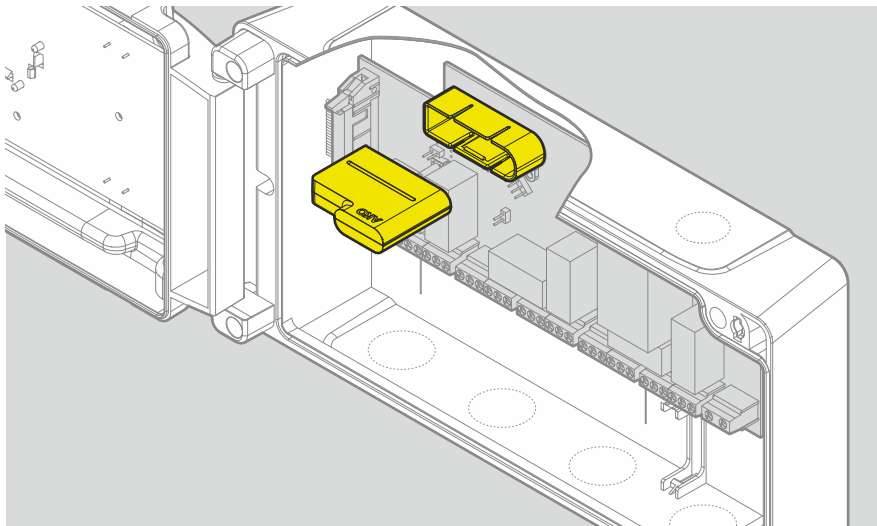

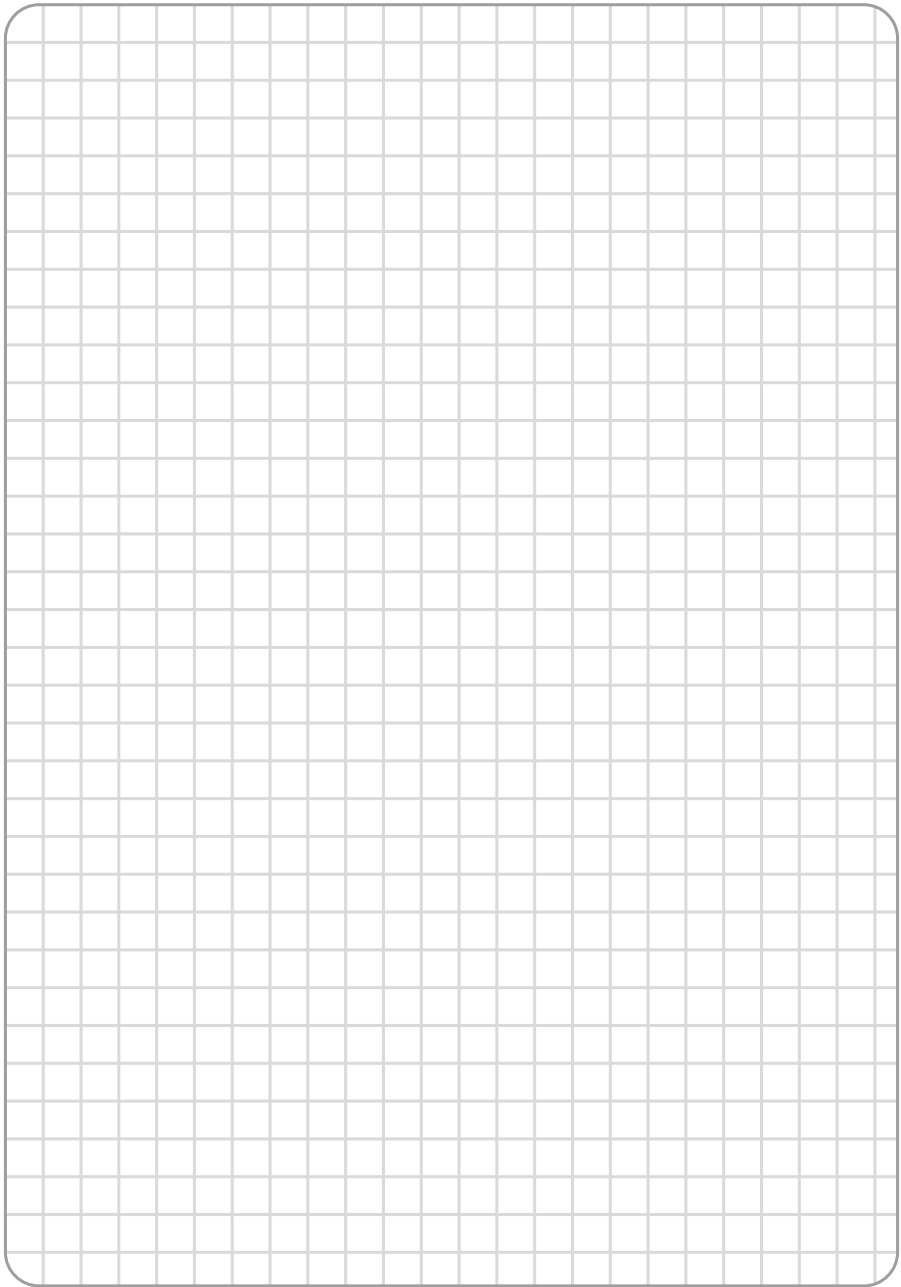

AKO ELECTROMECÁNICA, S.A.L.
Avda. Roquetes, 30-38
08812 • Sant Pere de Ribes.
Barcelona • Spain.

Tel.: +34 902 333 145
Fax: +34 938 934 054
www.ako.com

35 1652302 REV.07 2019