

COOL-FIT 4.0

Pre-insulated system for industrial and commercial refrigeration

Increased efficiency and safety for food and beverage production
and for the storage of food





GF Piping Systems

Building the lifelines of the world

GF Piping Systems is the global specialist for the safe and reliable transportation of water, chemicals, and gas. Customers in more than 100 countries implement our solutions to work more safely, efficiently, and cost-effectively.

Your partner for modern plastic systems

Customers in more than 100 countries are already working with the plastic piping systems that GF Piping Systems introduced more than 60 years ago. They are maintenance-free, resistant to corrosive and aggressive media, and are extremely durable. Their low weight, compared to metal systems, reduces static and logistic requirements. An innovative design and modern jointing technologies allow faster and easier installations. All this helps our customers to work more safely, efficiently, and cost-effectively. Support throughout the transition from metal to plastic systems is a key focus for our specialists.

+ Maintenance-free plastic

Plastics are corrosion-free and maintenance-free. They have excellent chemical resistance and last as long as the system itself, which is more than 25 years.

+ Complete system solutions

Our portfolio of more than 60,000 products offers complete system solutions, meaning you get perfectly matched components from a single source.

+ Local support

GF Piping Systems specialists are located in 34 countries and are therefore always close at hand, meaning that advice and on-site practical assistance is never far away.

+ Partner in all project phases

The specialists from GF Piping Systems support you throughout all phases of your project – starting from the planning stage, right through to commissioning. This reduces both the time required and risks.

+ Many years of experience

GF Piping Systems is a division of Georg Fischer AG, based in Schaffhausen, Switzerland, which was established in 1802. You benefit from our many years of experience.

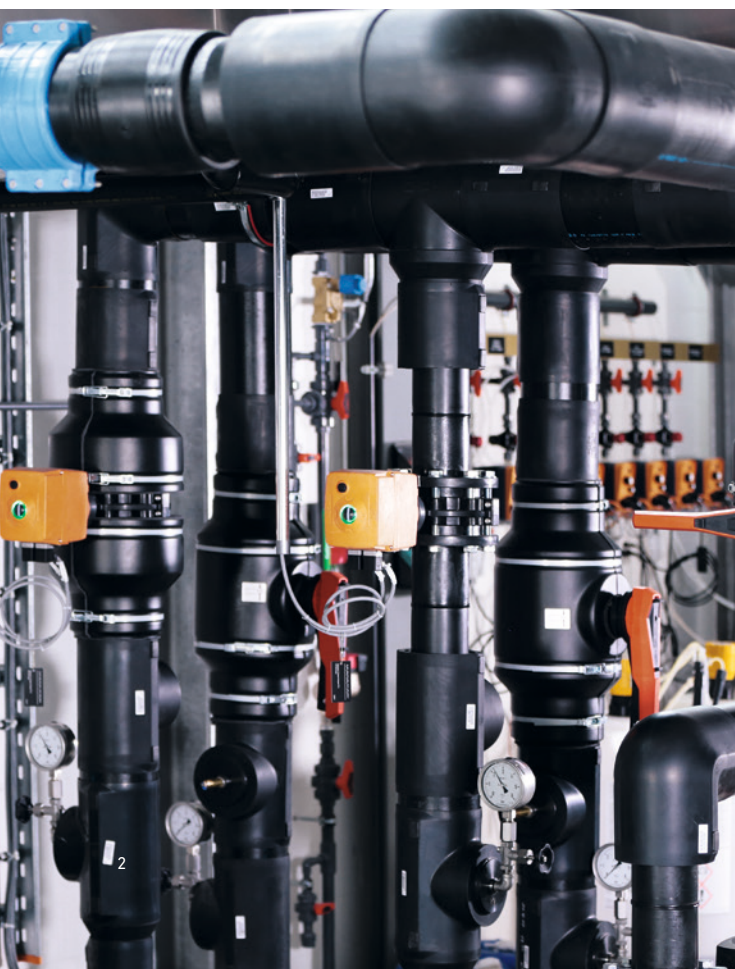

Efficient cooling with COOL-FIT 4.0

Poor insulation and corroding piping in cooling systems are more than just a nuisance, they pose a hazard to production safety and product quality. Moreover, they cause unnecessarily high maintenance and energy costs. GF Piping Systems offers solutions to help you to optimize your cooling system from the ground up. These solutions ensure continuous production processes, reduce operational downtimes due to leakages and other corrosion damage, and cut your maintenance and operating costs.

The pre-insulated COOL-FIT 4.0 piping system for commercial and industrial refrigeration is particularly beneficial for food and beverage manufacturers and processors. On the following pages, you will find out more about safe and efficient cooling with COOL-FIT 4.0 and how this system can support you.

Content

Building the lifelines of the world	2 – 3
Partner with GF Piping Systems	
Safe cooling has never been so easy	4 – 5
The benefits of COOL-FIT for you	
Increased safety and efficiency	6 – 9
COOL-FIT 4.0 for commercial and industrial refrigeration	
Applications	10 – 15
COOL-FIT 4.0 in food and beverage production, cold stores, and breweries	
Connected within just a few minutes	16 – 17
Safe and reliable with electrofusion	
The Tool Box	18
Safe and reliable with electrofusion	
Product range	19 – 46
The entire COOL-FIT 4.0 product range	



COOL-FIT

Safe, efficient cooling has never been so easy

COOL-FIT is the successful range of pre-insulated plastic piping systems from GF Piping Systems. It makes cooling applications more efficient than ever before – in all phases of your project. COOL-FIT simplifies planning and installation through superior design, pre-insulation, low weight, and modern jointing technologies. COOL-FIT reduces costs through completely maintenance-free operation, energy efficiency, and longevity (more than 25 years). COOL-FIT is environmentally friendly, thanks to its low carbon dioxide emissions throughout the entire service life of the product. The specialists at GF Piping Systems support you in this during all project phases.



100% maintenance-free

The media pipe, insulation, and jacket are made of plastic and therefore remain corrosion- and maintenance-free throughout the entire operating life of the system. This reduces expensive downtimes and lowers maintenance costs and personnel requirements.

100% reliable

The especially smooth interior surfaces of the medium pipe, typical for plastic systems, prevent deposits. The result: no loss of pressure over the entire service life. COOL-FIT remains as efficient as on its first day of operation.

65% less weight

COOL-FIT is significantly lighter than traditional metal systems and therefore places lower structural demands on buildings and supporting structures. The use of heavy transport aids can be reduced at the construction site.

50% faster installation

Factory pre-insulation eliminates the need for traditional insulation after the installation, which often requires a second team. You receive finished and permanently pre-insulated components, ready for immediate installation.

30% higher energy efficiency

In combination, the low thermal conductivity of plastic and the highly efficient foam insulation increase the energy efficiency of your system. This helps you to save energy costs and makes your work more environmentally friendly.



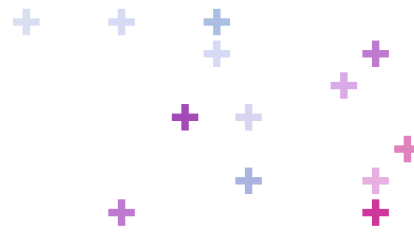

COOL-FIT 4.0

Maximum safety and efficiency for your production

COOL-FIT 4.0 is cutting-edge technology for users with the highest demands for production and process safety and for the storage of food. The pre-insulated piping system helps food and beverage manufacturers and processors to work at the highest level of safety and efficiency and to reduce costs.

Industrial and commercial refrigeration involves much more than just regulated temperatures. The focus is on production and process safety as well as the preservation of stored food. COOL-FIT 4.0 is the perfect solution for food and beverage manufacturers and processors.

COOL-FIT 4.0 is the pre-insulated piping system for secondary cooling with brine, glycol, ethanol, and chilled water. It is ideal for temperatures ranging from -50°C to 60°C . COOL-FIT 4.0 is cutting-edge technology that benefits fruit and vegetable processors, slaughterhouses, breweries, and supermarkets in particular. COOL-FIT 4.0 helps you to work with maximum efficiency and without disruption, while simultaneously reducing your maintenance and operating costs.

COOL-FIT 4.0 has the advantages of all COOL-FIT products compared to traditional metal systems:

- 100 % maintenance-free
- 100 % reliable
- 65 % less weight
- 50 % faster installation
- 30 % higher energy efficiency

In addition, COOL-FIT 4.0 offers further key benefits:

Connected within just a few minutes

COOL-FIT 4.0 allows for the simplest, safest, and fastest possible installation – no unnecessary or complicated tasks. The system can be installed neatly and easily. Electrofusion permanently connects pipes, fittings, and valves in just a few minutes.





COOL-FIT for the environment

COOL-FIT helps you to work in a more environmentally friendly and energy-efficient manner.

Compared to post-insulated metal systems, COOL-FIT is considerably more environmentally friendly and helps to work more energy-efficiently. For example: a cold store uses 1500 meters of piping to transport cold water for the cooling system. COOL-FIT releases about 100 tons carbon dioxide less than a metal system during production and operation. This saving is equivalent to a journey of 446,000 kilometers by car.

Outdoor installation

COOL-FIT 4.0 can also be installed outdoors without any problems. All surfaces are sealed, weatherproof, and UV-resistant. The sealing lip of the fittings surrounds the pipe and thus reliably protects the insulation from water and ice, ensuring a long service life.

Constant quality control

Thanks to the very few installation steps and the use of electrofusion as the jointing technology, COOL-FIT 4.0 enables a degree of control that was previously impossible. Installation errors are largely excluded from the outset, which ensures a system of the highest possible quality.

Clean and elegant system

Installing COOL-FIT 4.0 is safe and clean: no crumbling insulating foam, no sticky insulating tape or filling material, no open flame for closing the seals. The result is also aesthetically appealing, which is important for accessible plants and customer visits.



+ Carbon dioxide emission



+ Energy loss



COOL-FIT is on average 30 percent more energy efficient than metal piping systems that were subsequently insulated with rubber-based foam, in an otherwise identical installation.

Leading technology for easy installation and longevity

COOL-FIT 4.0 is the result of years of development by our engineers with the aim of making the system even easier and faster to install, yet at the same time, remaining as safe, reliable, and durable as you expect from all GF Piping Systems solutions. Many crucial details contribute to this.

System properties

Materials *	Media pipe	PE100
	Insulation	GF HE foam, halogen-free, closed-pore
	Outer jacket	Pipe: HDPE, fitting: GF-HE
Dimensions		d32 mm (DN25) – d450 mm (DN450)
Joining technology		Electrofusion joint
Pressure level	d32 – d110	PN 16 bar, SDR 11
	d160 – d450	PN 10 bar, SDR 17
Insulation	Thermal conductivity λ at 20°C	≤ 0.022 W/mK (d32 – d110), ≤ 0.026 W/mK (d160 – d450)
	Density	≥ 70 kg/m ³
	Foam cell size	max. \varnothing 0.5 mm
	Thickness (nominal value)	40 mm
Temperature	Medium	-50 °C to 60 °C (ambient -30 °C to 60 °C)
Weight (without liquid)	Pipe d32 mm	1.41 kg/m
	Pipe d225 mm	16.6 kg/m
Environment	Resistance	Moisture- and vapor-proof
	Ozone Depletion Potential (ODP)	Zero
Standards	EN ISO 15494	Plastic piping systems for industrial applications – Metric series
	ISO 7	Fittings
	EN ISO 16135, EN ISO 16138	Industrial valves

* All three materials are permanently connected.

System components



Pipes

Fittings

Transitions

Valves

Flexible hoses

Tools



Pressure / Temperature

Medium: Water

Minimum service life: 25 years

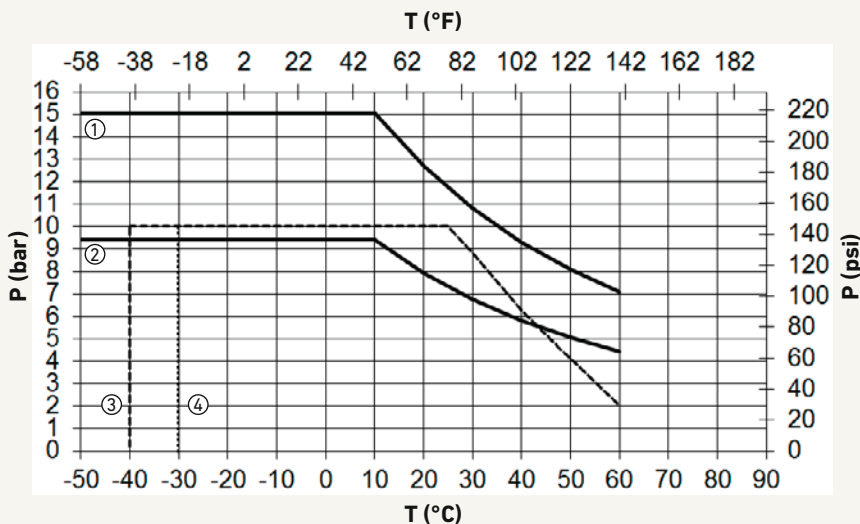

Note: With a water/glycol mixture $\leq 50\%$, the reduction factor for the pressure/temperature diagram 1.1 for pipes and fittings, and 1.7 for valves.

For PN16 or PN10 the safety factor is 1.25

P Operating pressure of the medium (bar, psi)
 T Temperature of the medium ($^{\circ}$ C, $^{\circ}$ F)
 C Safety factor

- ① COOL-FIT 4.0 pipe and fitting d32/D90 – d110/D180, C=1.6, SDR11
- ② COOL-FIT 4.0 pipe and fitting d160/D250 – d450/D630, C1.6, SDR17
- ③ COOL-FIT 4.0 ball valve PN10
- ④ COOL-FIT 4.0 butterfly valve PN10

Food and Beverage Production

Reduced production costs

During the manufacturing and processing of food and beverages, reliable cooling is essential for production that is both faultlessly hygienic and economically efficient. COOL-FIT 4.0 eliminates the risk of downtimes caused by corrosion damage in the cooling system and helps to comply with increasing environmental regulations. COOL-FIT 4.0 is ideal for conversion of secondary cooling systems and connection to existing systems.

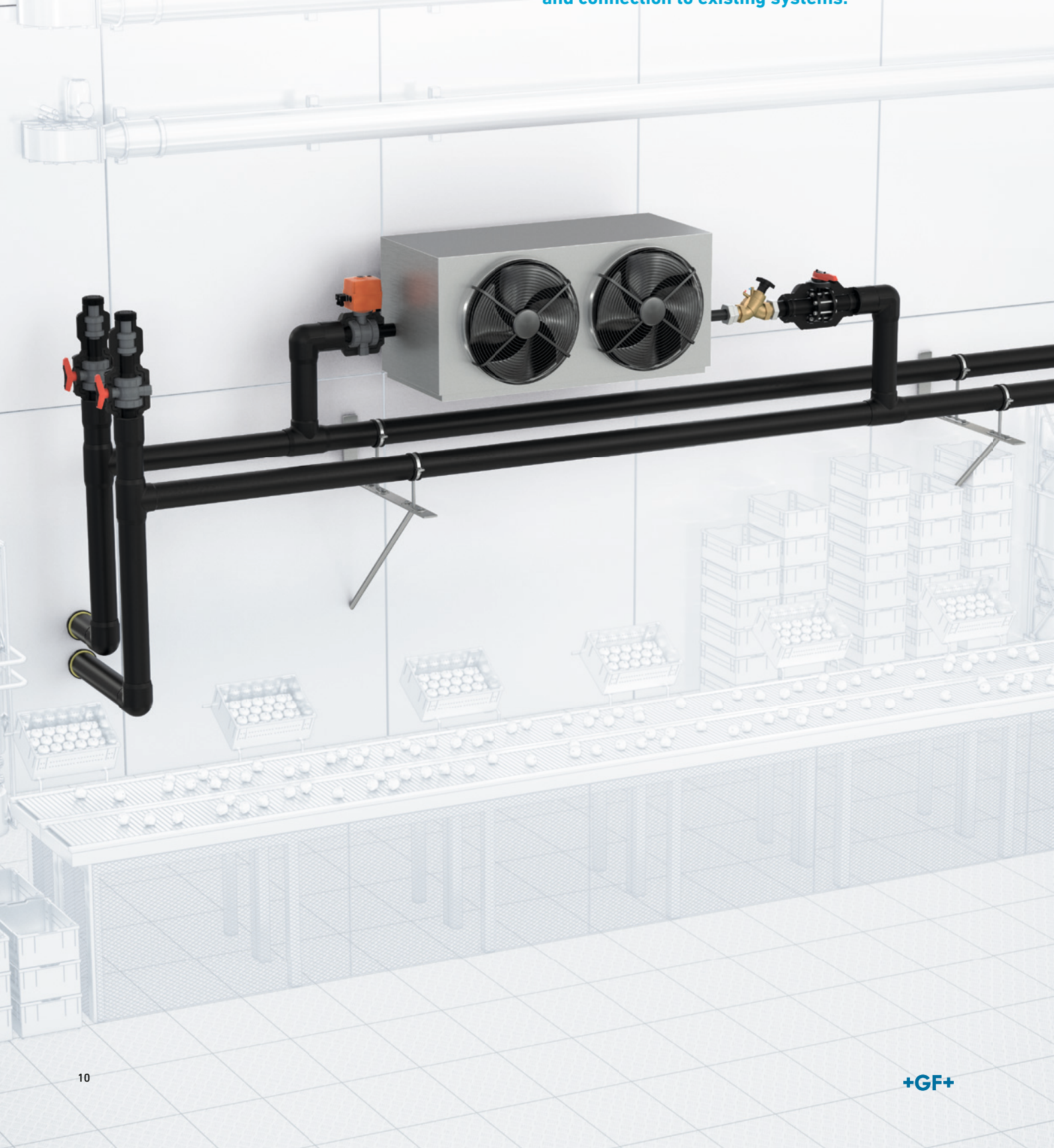



Easy transitions to metal systems

The COOL-FIT 4.0 adapter fittings enable simple and fast transition to metal systems, valves, end devices, and chillers, allowing for effortless connection of adjacent systems.



Pre-insulated electrofusion fittings

The range of COOL-FIT 4.0 fittings includes pre-insulated elbows, tees, couplers, and reducers. Electrofusion ensures secure joints within just a few minutes, with integrated quality control.

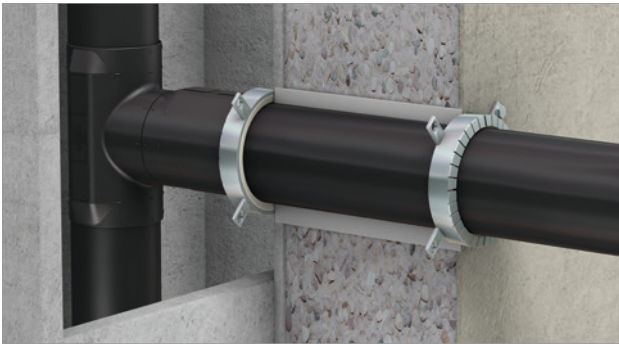

Certified fire protection collars

Often, food and beverage production take places across several compact production areas. In the event of a fire, the fire protection collars reliably seal them off from each other for up to 120 minutes.



Proven fixed point solutions

The fixed point solutions from GF Piping Systems can be welded easily onto the outer jacket. They ensure professional, tension-free installation of COOL-FIT 4.0, even under difficult fitting conditions.

Your benefits

- Highest degree of protection from production downtimes and loss of goods caused by corrosion damage
- Ideal for conversion to secondary cooling to meet environmental regulations
- Fast installation and commissioning with pre-insulation and electrofusion
- Support throughout all project phases provided by local specialists from GF Piping Systems



Cold Stores

Safety throughout the cold chain

In cold stores, the reliability of the system determines the preservation of the stock and thus the economic base of the company. COOL-FIT 4.0, as a high-quality plastic system, eliminates the risk of interruptions in the cold chain and product losses due to corrosion. The system can also be installed outdoors, if required. The outstanding insulation properties of COOL-FIT 4.0 make it possible to reduce cooling costs and to work more profitably.

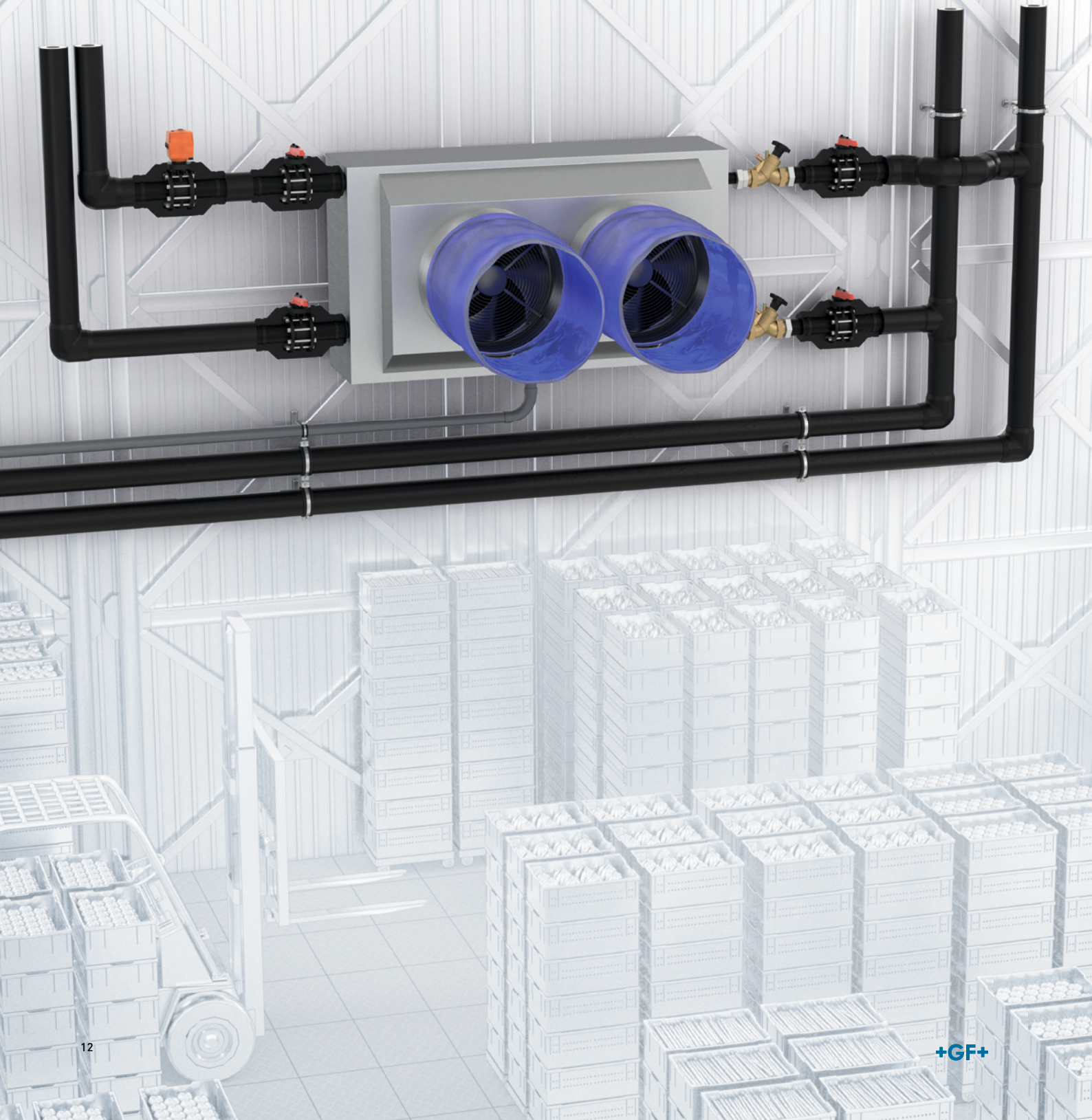



Pre-insulated pipes for fast installation

In cold stores, long, straight pipe sections are common due to their often considerable size. The pre-insulation of COOL-FIT 4.0 supports fast installation, with all pipes stripped at both ends at the factory.



Uncomplicated flange connections

Connection to existing metal systems is made straightforward with the use of flange connections. The COOL-FIT 4.0 range includes the appropriate flange adaptor, which is precisely encased by the insulation shells.



Pre-insulated butterfly valves

In addition to ball valves, butterfly valves are among the most frequently used valves in cold stores. They are pre-insulated in the COOL-FIT 4.0 system, just like all other system components. They are available from d110 to d225 as standard.

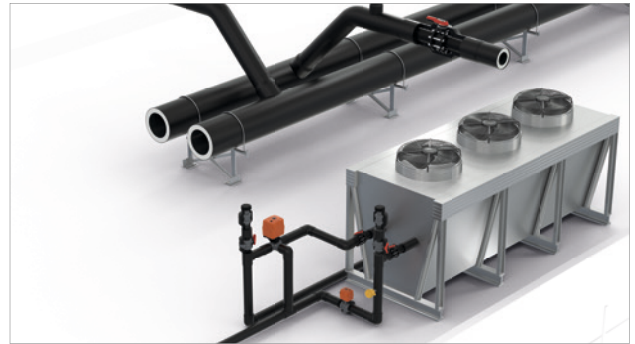

Safe even when installed outdoors

In order to use production areas efficiently, it is often necessary to relocate part of the installation outdoors, such as on the roof. No problem for COOL-FIT 4.0: the system is watertight, weatherproof, and resistant to UV radiation.

Your benefits

- Highest degree of protection against system failures by means of corrosion-free plastic components
- Safe outdoor installation (e.g. on the roof) without any additional protective elements
- Fast installation and commissioning with pre-insulation and electrofusion
- Support throughout all project phases provided by local specialists from GF Piping Systems



Breweries

Corrosion-free production

Corrosion resistance is particularly important in breweries, because to the constant use of water and liquid primary products. COOL-FIT 4.0, as a pre-insulated plastic system, is ideal for this use, especially for control and conditioning the fermentation. The installation in historical production buildings and irregularly shaped storage cellars can be challenging. Our local specialists are available to support you during each project phase.





Electrical valves with pre-insulation

In addition to butterfly valves, the COOL-FIT 4.0 range includes ball valves, operated manually or electrically. They are pre-insulated, as is the entire system, and are therefore as quick and easy to install as all the other components.



Flexible hoses for the tanks

Fermentation tanks often have no clearly defined angles on their slightly irregular arched undersides, making it difficult to install normal fittings. Here, pre-insulated flexible hoses ensure a secure connection.



Installation fittings for sensors

Sensors for measuring pressure, temperature, and other variables can be easily integrated with installation fittings. The sensors are screwed in, drilling is not necessary. This method reduces the risk of leakage.



Range of tools and training

The tools from GF Piping Systems enable the installer to achieve a fast and high-quality installation of COOL-FIT 4.0. Our local specialists also provide support with training sessions, if required.

Your benefits

- **Cost reduction thanks to a corrosion-free, and thus maintenance-free, piping system**
- **Flexibility during system planning thanks to a wide range of pre-insulated components**
- **Fast installation and commissioning with pre-insulation and electrofusion**
- **Support throughout all project phases provided by local specialists from GF Piping Systems**



Joined in minutes by electrofusion

The COOL-FIT 4.0 pipes, fittings, and valves can be connected neatly, easily, and within just a few minutes by electrofusion. On this page you can find the most important processing steps and the technical differences among the dimension ranges d32 - d225 and d250 - d450.

Diameter d32 - d225

Features & Processing steps nominal

- The pipes are already stripped and peeled on delivery
- A sealing lip seals the insulations from each other
- All fittings are available as an electrofusion version

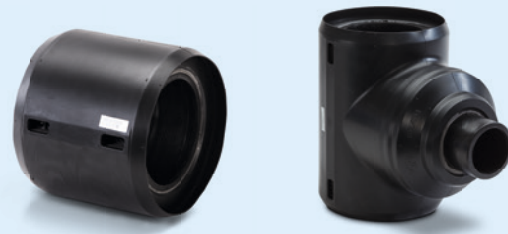

Clean the fusion zones of the fitting and pipe using a clean cloth.



Place the mounting aid on the fitting. Stretch the sealing lip pressing the handles together.



Slide the ends of the pipe into the fitting as far as the marking. Then remove the mounting aid.



Connect the welding cables to the welding contacts of the fitting and weld according to the instruction manual.

Here you can find the video tutorial for the installation
gfps.com/cf4-installation-d225



One of the most significant benefits of COOL-FIT 4.0 is the clean, simple, and fast installation by electrofusion. Even plumbers without any training in welding find it easy to install COOL-FIT 4.0 and check the quality of the installation.



Diameter d250 - d450

Features & Processing steps nominal

- Pipes and fittings must be peeled before installation
- Insulations are sealed from each other with a sealing tape and shrink sleeves
- Spigot fitting (type B) connected with electrofusion coupler (type A)

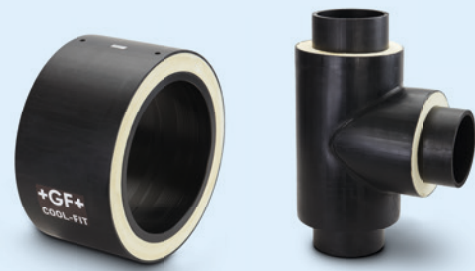

Peel the ends of the pipe and fitting type B and clean the fusion zones of the fitting and pipe using a clean cloth.



Slide-on the shrink sleeves and push the pipe ends up to the stop into the electrofusion coupler.



Connect the welding cables to the welding contacts of the fitting and weld according to the instruction manual.



Seal the jointing face between the fitting and pipe with sealing tape and shrink the shrink sleeves.



Here you can find the video tutorial for the installation
gfps.com/cf4-installation-d450



How can COOL-FIT 4.0 help you?

+ Support from GF specialists

COOL-FIT 4.0 is a technically superior system. And it is more than the sum of its components, because it is supplemented by service from GF Piping Systems in all phases of your project – starting from the planning stage, right through to commissioning. You can find our local specialists in 34 countries, meaning they are always close at hand. This also allows for personal discussions at your company, as well as at the construction site during the installation phase.

With GF Piping Systems at your side, you can always count on having a competent contact person. This includes assistance with the necessary calculations, especially if you have little experience with plastic systems, as well as product selection, installation, and final quality inspection.

+ Next steps

- Consultation with your GF Piping Systems specialists
- Consultation on the benefits of COOL-FIT 4.0 for you
- Information on reference applications
- Assistance with product selection and making calculations
- Support throughout all project phases

Get in touch with us
gfps.com/cf4-contact



COOLING Tool-Box

The cooling calculation tool from GF Piping Systems supports the dimensioning and design of the secondary circuit. The cooling calculation tool includes the following calculation functions:

- Expansion / contraction
- Length of the flexible sections
- Energy saving
- Surface temperatures
- Pipe dimensioning
- Pressure losses
- Dew point, including insulation strength
- Bracket spacing
- Freezing time
- Weight comparison
- CO₂ footprint

Use the online calculator
gfps.com/cooling-tools

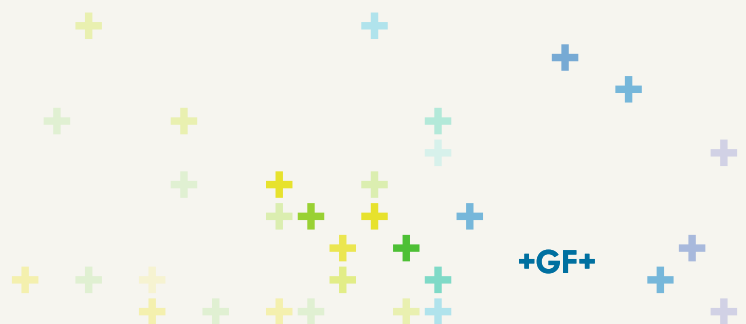

COOL-FIT 4.0

Product range



COOL-FIT 4.0

COOL-FIT 4.0 Pipes

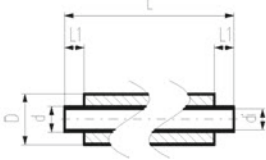

COOL-FIT 4.0 Pipe, d32-d225

Model:

- Pre-insulated PE100 SDR11/17 metric
- Insulation made from GF HE foam
- Impact resistant. Color: black
- Length: 5m
- With free ends for electrofusion

d/D (mm)	DN (mm)	SDR	PN (bar)	Code	Weight (kg/m)	di (mm)	L (mm)	L1 (mm)	closest inch (inch)
32/90	25	11	16	738 173 108	1.411	26.2	5000	36	1
40/110	32	11	16	738 173 109	2.054	32.6	5000	40	1 ½
50/110	40	11	16	738 173 110	2.221	40.8	5000	44	1 ½
63/125	50	11	16	738 173 111	2.987	51.4	5000	48	2
75/140	65	11	16	738 173 112	3.757	61.4	5000	55	2 ½
90/160	80	11	16	738 173 113	4.819	73.6	5000	62	3
110/180	100	11	16	738 173 114	6.200	90.0	5000	72	4
160/250	150	17	10	738 173 117	9.921	141.0	5000	90	6
225/315	200	17	10	738 173 120	16.620	198.2	5000	110	8

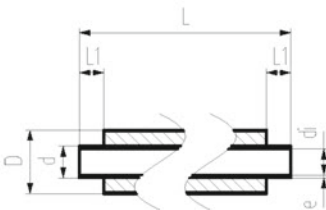
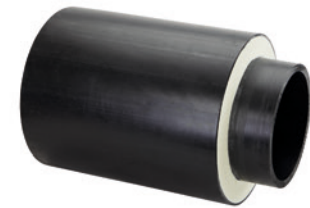

COOL-FIT 4.0 Pipe, d250-d450

Model:

- Pre-insulated PE100 SDR 17 metric
- Insulation made from GF HE foam
- Outer jacket impact resistant. Color: black
- Length: 5.9m
- With free ends for electrofusion

d/D (mm)	PN (bar)	Code	Weight (kg/m)	di (mm)	L (mm)	L1 (mm)	closest inch (inch)
250/355	10	738 173 021	18.180	220.4	5900	123	10
280/400	10	738 173 022	22.640	246.8	5900	126	10
315/450	10	738 173 023	28.510	277.6	5900	133	12
355/500	10	738 173 024	35.350	312.8	5900	145	14
400/560	10	738 173 125	44.070	352.6	5900	147	16
450/630	10	738 173 126	55.490	396.6	5900	163	18

COOL-FIT 4.0 Fittings



COOL-FIT 4.0 Coupler, d32-d225

Model:

- Pre-insulated PE100 SDR 11 metric
- Insulation made from GF HE foam
- Impact resistant. Color: black
- Integrated sealing lip, for a moisture-proof and vapour tight sealing

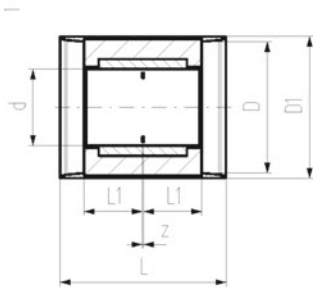

d/D (mm)	DN (mm)	PN (bar)	Code	Weight (kg)	D1 (mm)	L (mm)	L1 (mm)	z (mm)	closest inch (inch)
32/90	25	16	738 913 108	0.089	97	127	36	5	1
40/110	32	16	738 913 109	0.129	117	133	40	3	1 ¼
50/110	40	16	738 913 110	0.169	117	141	44	3	1 ½
63/125	50	16	738 913 111	0.240	132	149	48	3	2
75/140	65	16	738 913 112	0.520	147	163	55	3	2 ½
90/160	80	16	738 913 113	0.750	168	178	62	4	3
110/180	100	16	738 913 114	0.831	188	198	72	4	4
160/250	150	16	738 913 117	1.726	258	233	90	3	6
225/315	200	16	738 913 120	3.783	324	275	110	5	8

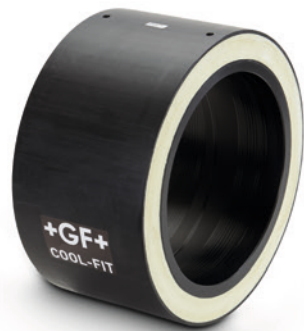

COOL-FIT 4.0 Coupler, d250-d450

Model:

- Pre-insulated PE100 SDR 17 metric
- Insulation made from GF HE foam
- Outer jacket impact resistant. Color: black

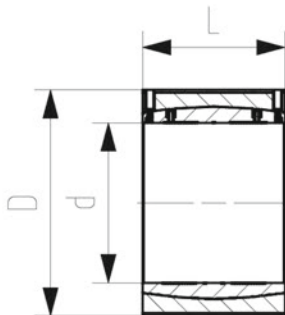

d/D (mm)	PN (bar)	Code	Weight (kg)	L (mm)	closest inch (inch)
250/355	10	738 911 821	4.616	247	10
280/400	10	738 911 822	1.000	252	10
315/450	10	738 911 823	13.800	267	12
355/500	10	738 911 824	1.000	290	14
400/560	10	738 911 875	19.000	294	16
450/630	10	738 911 876	1.000	326	18



COOL-FIT 4.0 Elbow 90°, d32-d225

Model:

- Pre-insulated PE100 SDR11, metric
- Insulation made from GF HE foam
- Outer jacket impact resistant. Color: black
- A: Electrofusion Fitting with integrated sealing lip, for a water and vapour tight sealing

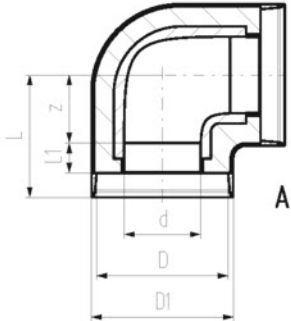

d/D (mm)	PN (bar)	Code	Weight (kg)	D1 (mm)	L (mm)	L1 (mm)	z (mm)	closest inch	Type
32/90	16	738 103 108	0.255	97	81	36	20	1	A
40/110	16	738 103 109	0.177	117	88	40	23	1 ¼	A
50/110	16	738 103 110	0.250	117	99	44	30	1 ½	A
63/125	16	738 103 111	0.372	132	107	48	34	2	A
75/140	16	738 103 112	0.800	147	120	55	40	2 ½	A
90/160	16	738 103 113	1.500	168	150	62	63	3	A
110/180	16	738 103 114	1.950	188	174	72	77	4	A
160/250	16	738 103 117	5.200	258	220	90	105	6	A
225/315	16	738 103 120	12.400	324	345	110	210	8	A

COOL-FIT 4.0 Bend 90°, d250-d450

Model:

- Pre-insulated PE100 SDR 17 metric
- Insulation made from GF HE foam
- Outer jacket impact resistant. Color: black
- B: Spigot Fitting with free end (separate electrofusion fitting needed for joining)

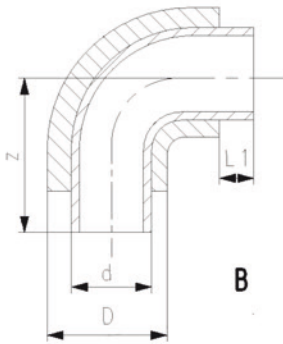

d/D (mm)	PN (bar)	Code	Weight (kg)	L1 (mm)	z (mm)	closest inch	Type
250/355	10	738 003 121	11.800	123	375	10	B
280/400	10	738 003 122	16.560	126	430	10	B
315/450	10	738 003 123	28.800	133	470	12	B
355/500	10	738 003 124	25.000	145	900	14	B
400/560	10	738 003 175	59.640	147	980	16	B
450/630	10	738 003 176	79.200	163	1070	18	B



COOL-FIT 4.0 Elbow 45°, d32-d225

Model:

- Pre-insulated PE100 SDR11, metric
- Insulation made from GF HE foam
- Outer jacket impact resistant. Color: black
- A: Electrofusion Fitting with integrated sealing lip, for a water and vapour tight sealing

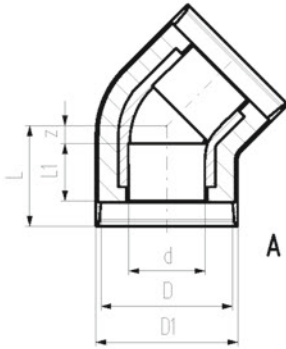

d/D (mm)	PN (bar)	Code	Weight (kg)	D1 (mm)	L (mm)	L1 (mm)	z (mm)	closest inch	Type
32/90	16	738 153 108	0.108	97	72	36	11	1	A
40/110	16	738 153 109	0.162	117	76	40	11	1 ¼	A
50/110	16	738 153 110	0.218	117	82	44	13	1 ½	A
63/125	16	738 153 111	0.315	132	89	48	16	2	A
75/140	16	738 153 112	0.650	147	98	55	18	2 ½	A
90/160	16	738 153 113	1.030	168	117	62	30	3	A
110/180	16	738 153 114	1.270	188	138	72	41	4	A
160/250	16	738 153 117	4.100	258	161	90	46	6	A
225/315	16	738 153 120	17.603	324	278	110	143	8	A

COOL-FIT 4.0 Bend 45°, d250-d450

Model:

- Pre-insulated PE100 SDR 17 metric
- Insulation made from GF HE foam
- Outer jacket impact resistant. Color: black
- B: Spigot Fitting with free end (separate electrofusion fitting needed for joining)



d/D (mm)	PN (bar)	Code	Weight (kg)	L1 (mm)	z (mm)	closest inch	Type
250/355	10	738 053 121	12.840	123	440	10	B
280/400	10	738 053 122	18.000	126	460	10	B
315/450	10	738 053 123	21.360	133	535	12	B
355/500	10	738 053 124	18.720	145	620	14	B
400/560	10	738 053 175	43.920	147	650	16	B
450/630	10	738 053 176	54.360	163	680	18	B

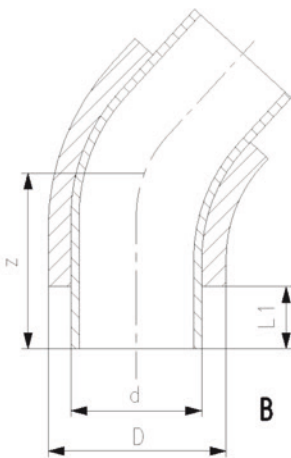



COOL-FIT 4.0 T90° equal, d32-d225

Model:

- Pre-insulated PE100 SDR11, metric
- Insulation made from GF HE foam
- Outer jacket impact resistant. Color: black
- A: Electrofusion Fitting with integrated sealing lip, for a water and vapour tight sealing

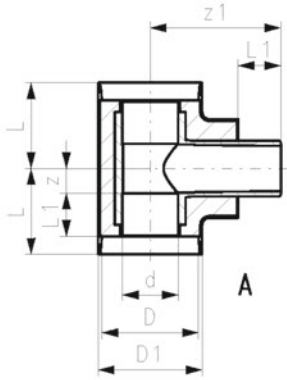

d/D (mm)	PN (bar)	Code	Weight (kg)	D1 (mm)	L (mm)	L1 (mm)	z (mm)	z1 (mm)	closest inch (inch)	Type
32/90	16	738 203 108	0.161	97	79	36	18	118	1	A
40/110	16	738 203 109	0.257	117	87	40	22	132	1 ¼	A
50/110	16	738 203 110	0.342	117	94	44	25	138	1 ½	A
63/125	16	738 203 111	0.514	132	103	48	30	154	2	A
75/140	16	738 203 112	1.000	147	116	55	36	168	2 ½	A
90/160	16	738 203 113	1.400	1668	130	62	43	187	3	A
110/180	16	738 203 114	2.500	188	154	72	57	207	4	A
160/250	16	738 203 117	5.600	258	192	90	77	263	6	A
225/315	16	738 203 120	16.748	324	355	110	220	337	8	A

COOL-FIT 4.0 T90° equal, d250-d450

Model:

- Pre-insulated PE100 SDR 17 metric
- Insulation made from GF HE foam
- Outer jacket impact resistant. Color: black
- B: Spigot Fitting with free end (separate electrofusion fitting needed for joining)

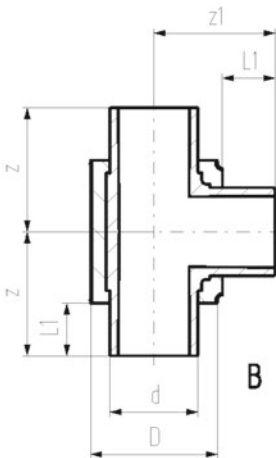

d/D (mm)	PN (bar)	Code	Weight (kg)	L1 (mm)	z (mm)	z1 (mm)	closest inch (inch)	Type
250/355	10	738 203 121	12.000	123	500	500	10	B
280/400	10	738 203 122	1.000	126	500	500	10	B
315/450	10	738 203 123	21.480	133	500	500	12	B
355/500	10	738 203 124	30.600	145	650	700	14	B
400/560	10	738 203 175	42.000	147	650	700	16	B
450/630	10	738 203 176	67.200	163	700	750	18	B



COOL-FIT 4.0 T90° reduced, d32-d225

Model:

- Pre-insulated PE100 SDR11, metric
- Insulation made from GF HE foam
- Outer jacket impact resistant. Color: black
- A: Electrofusion Fitting with integrated sealing lip, for a water and vapour tight sealing

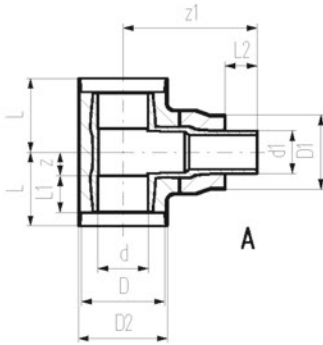

d/D (mm)	d1/D1 (mm)	PN (bar)	Code	Weight (kg)
75/140	63/125	16	738 203 218	0.863
90/160	63/125	16	738 203 222	1.232
90/160	75/140	16	738 203 223	1.293
110/180	63/125	16	738 203 227	1.972
110/180	75/140	16	738 203 228	1.949
110/180	90/160	16	738 203 229	2.037
160/250	63/125	16	738 203 247	5.150
160/250	90/160	16	738 203 249	5.147
160/250	110/180	16	738 203 250	5.220
225/315	63/125	16	738 203 264	16.832
225/315	90/160	16	738 203 266	16.889
225/315	110/180	16	738 203 267	16.805
225/315	160/250	16	738 203 269	18.500

d/D (mm)	d1/D1 (mm)	D2 (mm)	L (mm)	L1 (mm)	L2 (mm)	z (mm)	z1 (mm)	Closest inch (inch)	Type
75/140	63/125	147	116	55	48	36	228	2 ½	A
90/160	63/125	168	130	62	48	43	253	3 - 2	A
90/160	75/140	168	130	62	55	43	252	3 - 2 ½	A
110/180	63/125	188	154	72	48	57	267	4 - 2	A
110/180	75/140	188	154	72	55	57	268	4 - 2 ½	A
110/180	90/160	188	154	72	62	57	268	4 - 3	A
160/250	63/125	258	192	90	48	77	327	6 - 2	A
160/250	90/160	258	192	90	62	77	327	6 - 3	A
160/250	110/180	258	192	90	72	77	325	6 - 5	A
225/315	63/125	324	355	110	48	220	412	8 - 2	A
225/315	90/160	324	355	110	62	220	412	8 - 3	A
225/315	110/180	324	355	110	72	220	412	8 - 4	A
225/315	160/250	324	355	110	90	220	396	8 - 5	A



COOL-FIT 4.0 Reducer, d32-d225

Model:

- Pre-insulated PE100 SDR11, metric
- Insulation made from GF HE foam
- Outer jacket impact resistant. Color: black
- A: Electrofusion Fitting with integrated sealing lip, for a water and vapour tight sealing
- B: Spigot Fitting with free end



d/D (mm)	d1/D1 (mm)	PN (bar)	Code	Weight (kg)	D2 (mm)	L (mm)	L1 (mm)	L2 (mm)	z (mm)	Closest inch (inch)	Type
40/110	32/90	16	738 903 206	0.250	117	143	40	36	17	1 1/4 - 1	A
50/110	32/90	16	738 903 209	0.280	117	151	44	36	21	1 1/2 - 1	A
50/110	40/110	16	738 903 210	0.320	117	149	44	40	15	1 1/2 - 1 1/4	A
63/125	32/90	16	738 903 212	0.217	132	160	48	36	26	2 - 1	A
63/125	40/110	16	738 903 213	0.232	132	159	48	40	21	2 - 1 1/4	A
63/125	50/110	16	738 903 214	0.243	132	159	48	44	17	2 - 1 1/2	A
75/140	63/125	16	738 903 318	0.264			55	48	170	2 1/2 - 2	B
90/160	63/125	16	738 903 322	0.387			62	48	190	3 - 2	B
90/160	75/140	16	738 903 323	0.416			62	55	189	3 - 2 1/2	B
110/180	63/125	16	738 903 327	0.566			72	48	204	4 - 2	B
110/180	75/140	16	738 903 328	0.577			72	55	205	4 - 2 1/2	B
110/180	90/160	16	738 903 329	0.644			72	62	205	4 - 3	B
160/250	63/125	16	738 903 347	1.298			90	48	244	6 - 2	B
160/250	90/160	16	738 903 349	1.323			90	62	244	6 - 3	B
160/250	110/180	16	738 903 350	1.362			90	72	242	6 - 5	B
225/315	63/125	16	738 903 364	2.960			110	48	295	8 - 2	B
225/315	90/160	16	738 903 366	3.018			110	62	295	8 - 3	B
225/315	110/180	16	738 903 367	3.079			110	72	295	8 - 4	B
225/315	160/250	16	738 903 369	3.550			110	90	279	8 - 5	B

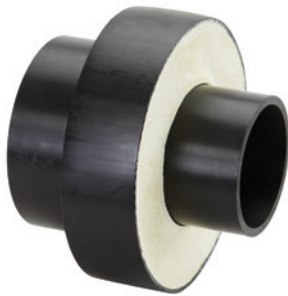
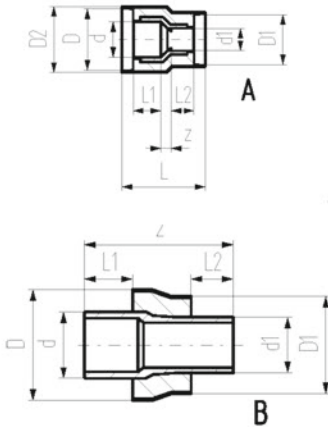

COOL-FIT 4.0 Reducer, d250-d450

Model:

- Pre-insulated PE100 SDR 17 metric
- Insulation made from GF HE foam
- Outer jacket impact resistant. Color: black
- B: Spigot Fitting with free end (separate electrofusion fitting needed for joining)

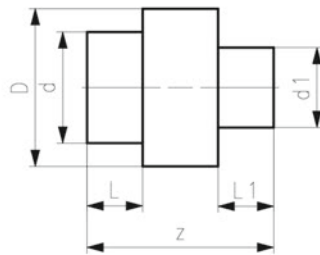

d (mm)	d1 (mm)	D (mm)	PN	Code	Weight (kg)	L (mm)	L1 (mm)	z (mm)	Type
250	225	355	PN 10	738 903 802	2.800	123	110	332	B
280	225	400	PN 10	738 903 899	4.700	126	110	335	B
315	225	450	PN 10	738 903 807	7.100	133	110	365	B
280	250	400	PN 10	738 903 803	5.100	126	123	340	B
315	250	450	PN 10	738 903 805	7.400	133	123	365	B
315	280	450	PN 10	738 903 806	6.800	133	126	365	B
355	250	500	PN 10	738 903 808	8.200	145	123	390	B
355	280	500	PN 10	738 903 809	7.700	145	126	390	B
355	315	500	PN 10	738 903 810	8.300	145	133	390	B
400	280	560	PN 10	738 903 871	9.100	147	126	415	B
400	315	560	PN 10	738 903 872	11.400	147	133	415	B
400	355	560	PN 10	738 903 873	11.000	147	145	420	B
450	280	630	PN 10	738 903 874	13.200	163	126	389	B
450	315	630	PN 10	738 903 875	13.600	163	133	390	B
450	355	630	PN 10	738 903 876	13.700	163	145	393	B
450	400	630	PN 10	738 903 877	14.800	163	147	395	B

COOL-FIT 4.0 Installation fitting type 313, d32-d225



Model:

- Pre-insulated, PE100, SDR11, metric
- Insulation made from GF HE foam
- Impact resistant. Color: black
- With threaded branch for sensors (i.e temperature, pressure)
- A: Electrofusion Fitting with integrated sealing lip, for a water and vapour tight sealing
- B: Spigot Fitting with free end

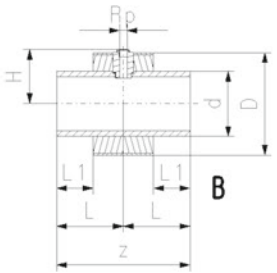
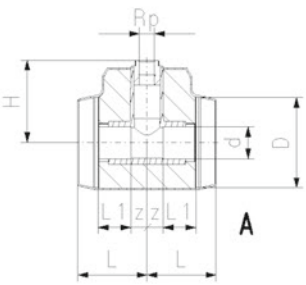

d/D (mm)	Rp (inch)	PN (bar)	Code	Weight (kg)	H (mm)	L (mm)	L1 (mm)	z (mm)	Type
32/90	½	16	738 313 608	0.169	95	79	36	18	A
40/110	½	16	738 313 609	0.267	105	87	40	22	A
40/110	¾	16	738 313 659	0.269	108	87	40	22	A
50/110	½	16	738 313 610	0.354	107	94	44	25	A
50/110	¾	16	738 313 660	0.356	110	94	44	25	A
63/125	½	16	738 313 611	0.537	120	103	48	30	A
63/125	¾	16	738 313 661	0.539	123	103	48	30	A
75/140	½	16	738 313 612	0.773	127	116	55	36	A
75/140	¾	16	738 313 662	0.774	130	116	55	36	A
90/160	½	16	738 313 613	1.164	139	130	62	43	A
90/160	¾	16	738 313 663	1.165	142	130	62	43	A
110/180	½	16	738 313 614	1.944	151	154	72	57	A
110/180	¾	16	738 313 664	1.944	154	154	72	57	A
160/250	½	16	738 313 617	2.496	134	165	90	330	B
160/250	¾	16	738 313 667	2.489	134	165	90	330	B
225/315	½	16	738 313 620	5.155	166	185	110	370	B
225/315	¾	16	738 313 670	5.146	169	185	110	370	B

COOL-FIT 4.0 Barrel nipple with insulation, d32-d225

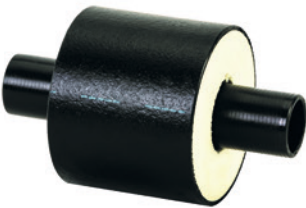

Model:

- Pre-insulated PE100 SDR11/17 metric
- Insulation made from GF HE foam
- Impact resistant. Color: black
- For short connections between COOL-FIT 4.0 Fittings Typ A

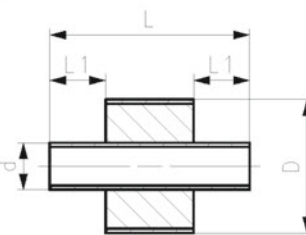

d/D (mm)	PN (bar)	SDR	Code	Weight (kg)	L1 (mm)	z (mm)	closest inch (inch)
32/90	16	11	738 913 408	0.126	36	151	1
40/110	16	11	738 913 409	0.188	40	155	1 ¼
50/110	16	11	738 913 410	0.226	44	163	1 ½
63/125	16	11	738 913 411	0.328	48	171	2
75/140	16	11	738 913 412	0.447	55	185	2 ½
90/160	16	11	738 913 413	0.631	62	199	3
110/180	16	11	738 913 414	0.929	72	219	4
160/250	10	17	738 913 417	1.576	90	255	6
225/315	10	17	738 913 420	3.254	110	295	8



COOL-FIT 4.0 Barrel nipple

Model:

- PE100, SDR11/17, metric
- For the shortest possible connection between fittings
- For media temperatures between 0°C up to 60°C
- COOL-FIT 4.0 Adhesive ring needed for joining

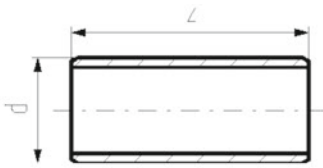

d (mm)	SDR	PN	Code	Weight (kg)	z (mm)	closest inch (inch)
32	11	16	738 910 408	0.020	72	1
40	11	16	738 910 409	0.034	80	1 ¼
50	11	16	738 910 410	0.059	88	1 ½
63	11	16	738 910 411	0.101	96	2
75	11	16	738 910 412	0.162	110	2 ½
90	11	16	738 910 413	0.264	124	3
110	11	16	738 910 414	0.454	144	4
140	11	16	738 910 416	0.855	168	5
160	17	10	738 910 417	0.798	180	6
225	17	10	738 910 420	1.885	220	8



COOL-FIT 4.0 adhesive ring

Model:

- Double sided, for sealing connections of fittings with barrel nipple

d (mm)	D (mm)	Code	Weight (kg)
32	90	738 010 013	0.002
40, 50	110	738 010 014	0.003
63	125	738 010 015	0.003
75	140	738 010 016	0.003
90	160	738 010 017	0.005
110	180	738 010 018	0.005
160	250	738 010 021	0.009
225	315	738 010 023	0.027

COOL-FIT 4.0 Transition Fittings



COOL-FIT 4.0 Adaptor fitting PE/stainless steel with loose union nut G

Model:

- Spigot fitting PE100 SDR11, metric with free end
- Stainless steel 1.4404 / 316L with female thread G
- Including flat seal EPDM
- Including insulation half shells

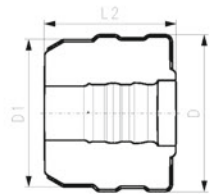
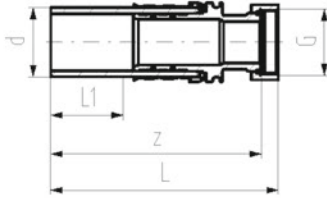

d (mm)	G (mm)	PN (bar)	Code	Weight (kg)	D (mm)	L (mm)	L1 (mm)	L2 (mm)	z (mm)
32	1/2"	16	738 943 308	0.250	104	133	36	101	126
32	3/4"	16	738 943 318	0.264	104	135	36	101	129
32	1"	16	738 943 328	0.296	104	135	36	101	129
40	1 1/4"	16	738 943 309	0.595	128	155	40	91	148
40	1 1/2"	16	738 943 319	0.655	128	157	40	91	148
50	1 1/2"	16	738 943 310	0.820	138	164	44	96	154
63	2"	16	738 943 311	1.307	149	186	48	103	170

COOL-FIT 4.0 Union PE/PE

Model:

- Union bush: Spigot fitting PE100 SDR11, metric with free end
- Union End: Spigot fitting PE100 SDR11, metric with free end
- Gasket: O-ring EPDM Nr. 748 410 008-014
- Union Nut: PEGF25
- Including insulation half shells

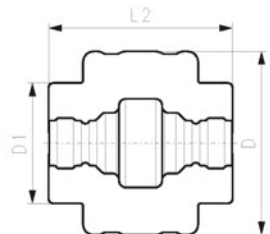
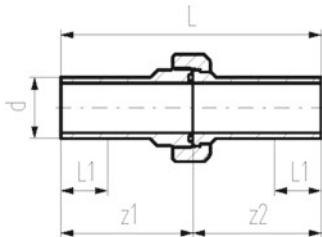

d (mm)	PN (bar)	Code	Weight (kg)	D (mm)	D1 (mm)	L (mm)	L1 (mm)	L2 (mm)	z1 (mm)	z2 (mm)
32	16	738 513 608	0.223	139	90	211	36	139	107	104
40	16	738 513 609	0.363	153	110	234	40	158	118	116
50	16	738 513 610	0.468	165	110	247	44	163	124	123
63	16	738 513 611	0.584	185	125	268	48	176	136	132

COOL-FIT 4.0 Adaptor Union PE/ABS



Model:

- Union bush: ABS Solvent cement socket
- Union End: Spigot fitting PE100 SDR11, metric with free end
- Gasket: O-ring EPDM Nr. 748 410 008-014
- Union Nut: ABS
- Including insulation half shells

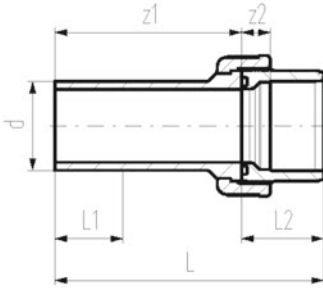

d (mm)	PN (bar)	Code	Weight (kg)	D (mm)	D1 (mm)	L (mm)	L1 (mm)	L2 (mm)	L3 (mm)	z1 (mm)	z2 (mm)
32	10	738 513 708	0.169	134	90	137	36	33	109	104	11
40	10	738 513 709	0.256	143	110	156	40	39	126	117	13
50	10	738 513 710	0.334	154	110	169	44	46	135	123	15
63	10	738 513 711	0.522	172	125	190	48	58	152	132	21
75	10	738 513 712	0.996	210	140	211	55	62	170	149	18
90	10	738 513 713	1.336	233	160	215	62	69	167	146	18
110	10	738 513 714	1.900	263	180	235	72	72	177	163	11

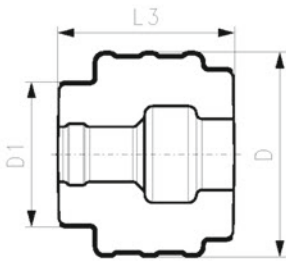

COOL-FIT 4.0 Adaptor fitting PE/iFIT



Model:

- Spigot fitting PE100 SDR11, metric with free end
- iFIT module stainless steel 1.4404 / 316L
- Including insulation half shells

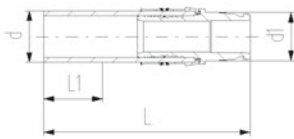

d (mm)	d1 (mm)	PN (bar)	Code	Weight (kg)	D (mm)	D1 (mm)	L (mm)	L1 (mm)	L2 (mm)
32	25-32	16	738 943 108	0.256	103	90	132	36	80

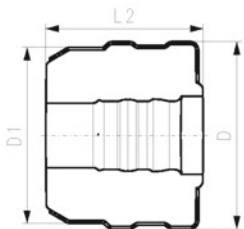



COOL-FIT 4.0 Adaptor fitting PE/Sanipex MT

Model:

- Spigot fitting PE100 SDR11, metric with free end
- Sanipex MT adaptor brass CuZn40Pb2
- Including insulation half shells

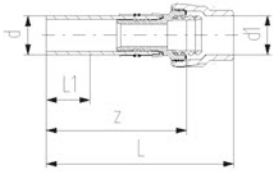

d	d1	PN	Code	Weight	D	D1	L	L1	L2	z
(mm)	(mm)	(bar)		(kg)	(mm)	(mm)	(mm)	(mm)	(mm)	(mm)
32	32	10	738 953 118	0.476	104	90	174	36	101	135

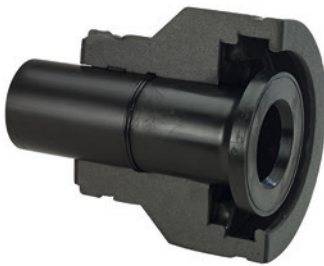
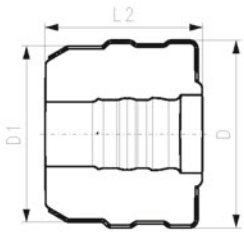

COOL-FIT 2.0/4.0 Flange adaptor

Model:

- PE100 SDR11, metric
- Suitable for flange connections to metric (from d110 also to ANSI/ASME B16.5)
- Gasket: Profile flange gasket NBR No. 45 44 07, EPDM No. 48 44 07
- Type 1 without chamfer, Type 2 with chamfer
- Separate Fittings type A needed for joining

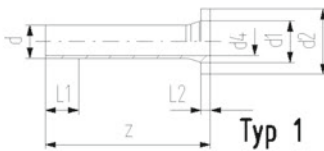

d	DN	PN	Code	Weight
(mm)	(mm)			(kg)
32	25	16	738 710 008	0.051
40	32	16	738 710 009	0.075
50	40	16	738 710 010	0.900
63	50	16	738 710 011	0.173
75	65	16	738 710 012	1.210
90	80	16	738 710 013	1.193
110	100	16	738 710 014	1.574
140	125	16	738 710 016	2.412
160	150	16	738 710 017	1.748
225	200	16	738 710 020	3.073

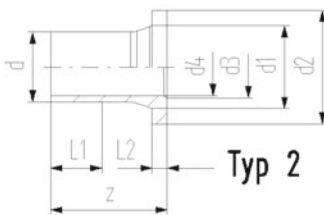

d	DN	D	D1	D2	L	L1	L2	L3	z	d1	d2	d3	d4	d5	Type
(mm)	(mm)	(mm)	(mm)	(mm)	(mm)	(mm)	(mm)	(mm)	(mm)	(mm)	(mm)	(mm)	(mm)	(mm)	
32	25	135	90	75	162	36	10	26	190	40	68		26	121	1
40	32	170	110	90	165	40	11	28	197	50	78		32	146	1
50	40	180	110	90	178	44	12	30	214	61	88		40	156	1
63	50	200	125	110	230	48	14	32	270	75	102		51	171	1
75	65	220	140	125	232	55	16	34	279	89	122		61	191	2
90	80	240	160	140	245	62	17	35	299	105	138	78	73	206	2
110	100	270	180	160	254	72	18	36	320	125	158	100	90	235	2
140	125	300	225	200	299	84	25	38	383	155	188	127	127	256	2
160	150	358	259		332	90	25	34	412	174	213	151	131	295	2
225	200	423	325		383	110	32	37	462	233	268	209	184	354	2

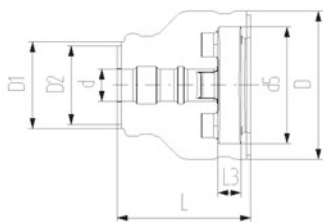

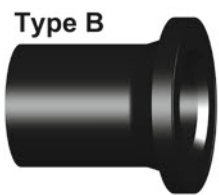
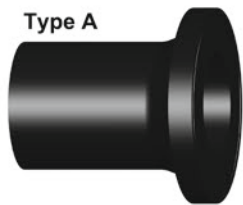

Flange adaptor PE100 SDR17/17.6 Combined jointing face: flat and serrated

Model:

- Long spigot
- Material: PE100
- For IR, butt- and electro fusion
- Suitable for flange connections to metric (from d110 also to ANSI/ASME B16.5)
- Gasket d20-d630: Profile flange gasket NBR No. 45 44 07, EPDM No. 48 44 07
- Gasket d710-d1000: flat gasket EPDM No. 48 40 03
- Type A without chamfer, Type B with chamfer
- 5 bar Gas / 10 bar Water
- Up to d400, suitable for butterfly valve type 567/578. Above use ecoFIT adaptor for butterfly valves SDR17.6 (d450-d1200)

* Not suitable for butterfly valves

** Installation support through moulded ribs

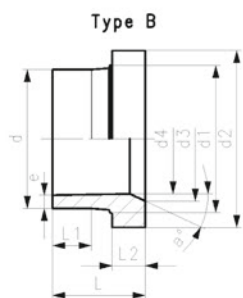
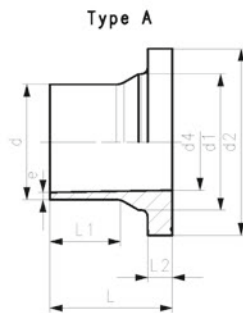

d (mm)	DN (mm)	FM	Code	Weight (kg)
250	250		753 800 096	3.500
280	250		753 800 097	3.780
315	300		753 800 098	5.470
**	355	350	753 800 299	7.100
**	400	400	753 800 300	9.600
**	450	500	753 800 301	16.400

d	d1	d2	d3	d4	L	L1	L2	e	Type	a°
(mm)	(mm)	(mm)	(mm)	(mm)	(mm)	(mm)	(mm)	(mm)		
250	285	320	245	220	220	148	35	14.8	B	25
280	291	320	265	246	230	154	35	16.6	B	30
315	335	370	300	277	242	166	36	18.7	B	30
**	355	373	430	346	310	170	33	21.1	B	21
**	400	427	482	395	350	185	36	23.7	B	21
**	450	514	585	400	316	205	46	26.7	A	



Backing flange PP-Steel metric For butt fusion systems metric

Model:

- Material: PP (30% glass-fibre reinforced) with steel ring
- Connecting dimension: ISO 7005, EN 1092, BS 4504, DIN 2501
- Bolt circle PN 10

AL: number of holes

¹⁾ Suitable for socket -and butt fusion systems

²⁾ Combined version, bolt circle metric - ANSI

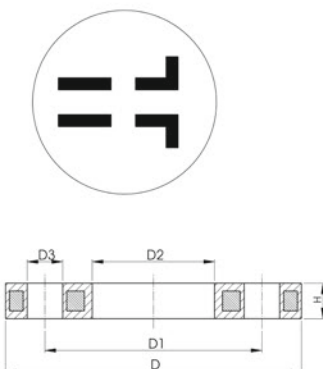

	d	DN	PN	Code	Weight	D	D1	D2	D3	H	AL	SC
	(mm)	(mm)	(bar)		(kg)	(mm)	(mm)	(mm)	(mm)	(mm)		
1	32	25	16	727 700 208	0.429	115	85	42	14	16	4	M12
1	40	32	16	727 700 209	0.621	140	100	51	18	16	4	M16
1	50	40	16	727 700 210	0.722	150	110	62	18	20	4	M16
1	63	50	16	727 700 211	0.900	165	125	78	18	20	4	M16
1	75	65	16	727 700 212	1.110	185	145	92	18	20	4	M16
	90	80	16	727 700 313	1.390	200	160	108	18	20	8	M16
	110	100	16	727 700 314	1.407	220	180	128	18	20	8	M16
	140	125	16	727 700 716	2.318	250	210	158	18	26	8	M16
2	160	150	16	727 700 717	3.491	285	241	178	22	26	8	M20
2	225	200	16	727 700 720	5.533	340	297	238	22	29	8	M20

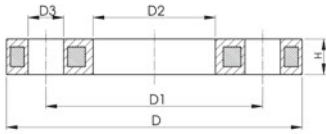

d (mm)	DN (mm)	PN (bar)	Code	Weight (kg)	D (mm)	D1 (mm)	D2 (mm)	D3 (mm)	H (mm)	AL	SC
250	250	16	727 700 721	6.632	395	350	288	22	32	12	M20
280	250	16	727 700 722	6.573	395	350	294	22	32	12	M20
315	300	16	727 700 723	7.903	445	400	338	22	36	12	M20
355	350	16	727 700 724	14.587	515	460	376	23	42	16	M20
400	400	16	727 700 725	20.034	574	515	430	26	42	16	M24



Profiled backing flange PP-Steel metric For butt fusion systems metric

Model:

- PP with glass-fibre reinforcement and GGG 50 insert
- Connecting dimensions: ISO 7005, EN 1092, DIN 2501
- Bolt circle PN 10

Note:

flat side = bolt side profiled side = flange adaptor side

AL: number of holes

* Galvanized steel S235-JR, suitable for underground laying



d (mm)	DN (mm)	PN (bar)	Code	Weight (kg)	D (mm)	D1 (mm)	D2 (mm)	D3 (mm)	H (mm)	AL	SC
* 450	450	10	724 705 026	38.000	615	565	470	26	36	20	M24
450	500	10	724 700 426	25.600	685	620	517	26	56	20	M24

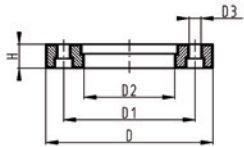

Blanking flange set PE Combined jointing face flat and serrated metric

Model:

- d63 - d315: backing flange PP-V with end blank PE
- d355 - d630: backing flange PP/Steel with end blank PE
- Connecting dimensions: ISO 7005, EN 1092, DIN 2501
- Bolt circle PN 10

AL: number of holes

L: length of the End Blank

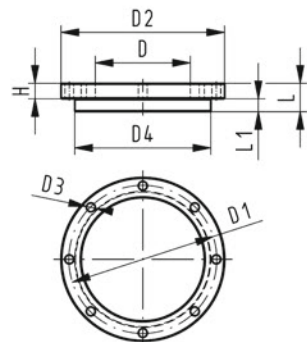

d (mm)	DN (mm)	PN (bar)	Code	Weight (kg)	D (mm)	D1 (mm)	D2 (mm)	D3 (mm)	D4 (mm)	L (mm)	L1 (mm)	H (mm)	AL	SC
63	50	16	753 700 611	0.560	75	125	165	18	102	30	14	24	4	M16
75	65	16	753 700 612	0.910	89	145	185	18	122	30	16	26	4	M16
90	80	16	753 700 613	0.921	105	160	200	18	138	30	17	27	8	M16
110	100	16	753 700 614	1.158	125	180	220	18	158	30	18	28	8	M16
140	125	16	753 700 616	1.913	155	210	250	18	188	40	25	30	8	M16
160	150	16	753 700 617	2.373	175	240	285	22	212	40	25	32	8	M20
225	200	16	753 700 620	3.744	235	295	340	22	268	50	32	34	8	M20
250	250	16	753 700 621	6.051	285	350	395	22	320	55	35	38	12	M20
280	250	16	753 700 622	6.305	291	350	395	22	320	60	35	38	12	M20
315	300	16	753 700 623	8.894	335	400	445	22	370	65	35	42	12	M20
355	350	16	753 700 624	23.198	373	460	515	22	430	70	40	40	16	M20
400	400	16	753 700 625	30.766	427	515	574	26	482	75	46	40	16	M24
450	500	10	753 700 626	44.271	510	620	684	26	585	80	60	49	20	M24

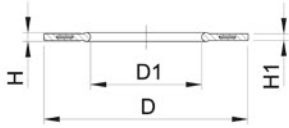

Profile Flange Gasket, metric EPDM / FKM

Model:

- For all metric GF Flange Adaptors
 - Hardness: 70° Shore EPDM, 75° Shore FKM
 - EPDM: approved acc. to DVGW Water W 270, KTW recommendation
 - Centering on the inner diameter of the screw crown
 - material steel insert: carbon steel
 - Rubber-steel body combined with rubber profile cord ring
- di FA are the suitable inner diameters of flanges adaptors

d (mm)	PN (bar)	DN (mm)	EPDM Code	FKM Code	Weight (kg)	D (mm)	D1 (mm)	di FA (mm)	H (mm)	H1 (mm)
32	16	25	748 440 708	749 440 708	0.019	71	28	18 - 28	4	3
40	16	32	748 440 709	749 440 709	0.026	82	40	30 - 40	4	3
50	16	40	748 440 710	749 440 710	0.039	92	46	36 - 46	4	3
63	16	50	748 440 711	749 440 711	0.050	107	58	48 - 58	5	4
75	16	65	748 440 712	749 440 712	0.082	127	69	59 - 69	5	4
90	16	80	748 440 713	749 440 713	0.083	142	84	73 - 84	5	4
110	16	100	748 440 714	749 440 714	0.127	162	104	94 - 104	6	5
140	16	125	748 440 716	749 440 716	0.173	192	137	127 - 137	6	5
160 - 180	16	150	748 440 717	749 440 717	0.207	218	160	150 - 160	8	6
225	16	200	748 440 720	749 440 720	0.255	273	220	207 - 220	8	6
250	16	250	748 440 721	749 440 721	0.462	328	252	238 - 252	8	6
280	16	250	748 440 722	749 440 722	0.323	328	274	264 - 274	8	6
315	16	300	748 440 723	749 440 723	0.549	378	306	296 - 306	8	6
355	16	350	748 440 724	749 440 724	0.870	438	355	340 - 355	10	7
400	16	400	748 440 725	749 440 725	1.088	489	400	385 - 400	10	7
450	16	500	748 440 726	749 440 726	0.718	594	403	393 - 403	10	7

COOL-FIT 4.0 Valves



COOL-FIT 4.0 Ball valve type 546, hand-operated

Model:

- Material: ABS with spigot PE100 SDR11, metric
- Ball seals PTFE
- Integrated stainless steel mounting inserts
- Including insulation half shells
- Separate Fittings type A needed for joining

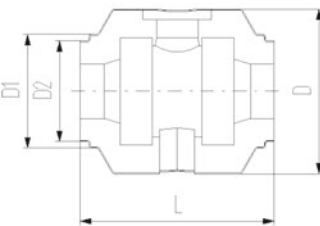
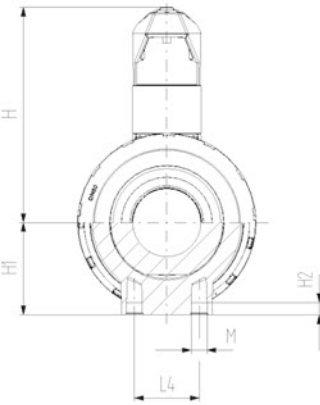
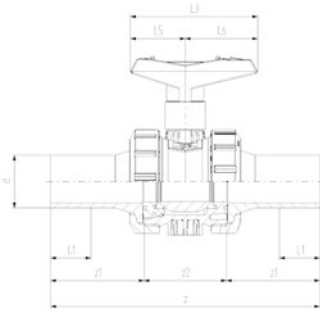

d (mm)	DN (mm)	PN	kv-value ($\Delta p=1$ bar) (l/min)	EPDM Code	Weight (kg)
32	25	10	700	138 546 108	0.542
40	32	10	1000	138 546 109	0.887
50	40	10	1600	138 546 110	1.165
63	50	10	3100	138 546 111	2.100
75	65	10	5000	138 546 112	5.125
90	80	10	7000	138 546 113	7.173

d (mm)	DN (mm)	D (mm)	D1 (mm)	D2 (mm)	L (mm)	L1 (mm)	L3 (mm)	H (mm)	H1 (mm)	H2 (mm)	z (mm)	z1 (mm)	z2 (mm)	closest inch (inch)
32	25	135	97	82	152	36	97	98	36	12	223	76	76	1
40	32	157	117	97	170	40	128	119	44	15	249	82	82	1 ¼
50	40	169	117	97	184	44	128	125	51	15	271	91	91	1 ½
63	50	204	132	117	227	48	152	150	64	15	321	110	110	2
75	65	235	147	132	276	55	270	194	85	15	386	125	125	2 ½
90	80	255	168	147	297	62	270	200	105	15	421	140	140	3

COOL-FIT 4.0 Ball valve type 179, electric



Model:

- Material: ABS with spigot PE100 SDR11, metric
- Ball seals PTFE
- Integrated stainless steel mounting inserts
- Voltage 100-230V, 50-60Hz
- Factory set control range 90°
- Heating element, position feedback (Open/Close/ Middle)
- Including insulation half shells
- Separate Fittings type A needed for joining

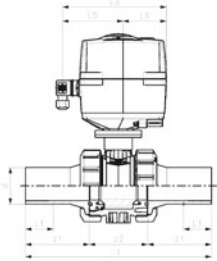

d (mm)	DN (mm)	PN (bar)	kv-value (dp=1bar)	Code	Weight (kg)
32	25	10	700	138 546 208	2.838
40	32	10	1000	138 546 209	3.174
50	40	10	1600	138 546 210	3.452
63	50	10	3100	138 546 211	4.475
75	65	10	5000	138 546 212	7.156
90	80	10	7000	138 546 213	8.488

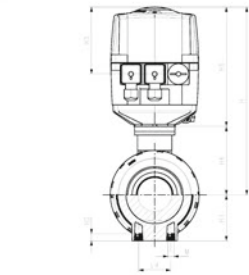

d (mm)	DN (mm)	D (mm)	D1 (mm)	D2 (mm)	L (mm)	L1 (mm)	L3 (mm)	L4 (mm)	H (mm)	H1 (mm)	H2 (mm)	z (mm)	z1 (mm)	z2 (mm)	M
32	25	135	97	82	152	36	190	25	228	36	12	223	76	71	M6
40	32	157	117	97	170	40	190	45	240	44	15	249	82	85	M8
50	40	169	117	97	184	44	190	45	246	51	15	271	91	89	M8
63	50	204	132	117	227	48	190	45	263	64	15	321	110	101	M8
75	65	235	147	132	276	55	190	70	322	85	15	386	125	136	M8
90	80	255	168	147	297	62	190	70	357	105	15	421	140	141	M8



d (mm)	DN (mm)	closest inch (inch)
32	25	1
40	32	1 ¼
50	40	1 ½
63	50	2
75	65	2 ½
90	80	3

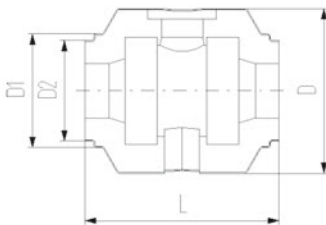



COOL-FIT 4.0 Butterfly valve kit type 567, hand-operated

Model:

- Material: ABS with spigot PE100 SDR11, metric
- Including flange adaptors, backing flanges PP-Steel, bolts and insulation half shells
- Separate Fittings type A needed for joining

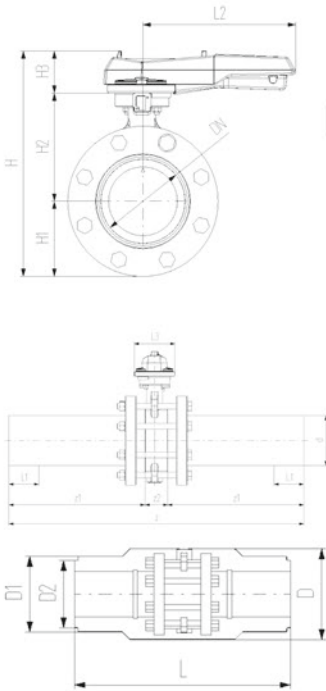

d (mm)	DN (mm)	PN	kv-value ($\Delta p=1$ bar) (l/min)	EPDM Code	Weight (kg)
110	100	10	6500	138 567 114	8.950
160	150	10	16600	138 567 117	17.975
225	200	10	39600	138 567 120	28.316

d (mm)	DN (mm)	D (mm)	D1 (mm)	D2 (mm)	L (mm)	L1 (mm)	L2 (mm)	L3 (mm)	H (mm)	H1 (mm)	H2 (mm)	H3 (mm)	z (mm)	z1 (mm)	z2 (mm)
110	100	310	188	168	556	72	255	106	325	104	167	55	696	320	56
160	150	358	259		720	90	255	115	143	143	203	55	895	412	72
225	200	409	325		776	110	408	149	465	170	210	85	996	462	73

d (mm)	DN (mm)	closest inch (inch)
110	100	4
160	150	5
225	200	8

COOL-FIT 4.0 Butterfly valve kit type 145, electric

Model:

- Material: ABS with spigot PE100 SDR11, metric
- Voltage 100-230V, 50-60Hz
- Factory set control range 90°
- Heating element, position feedback (Open/Close/ Middle)
- Including flange adaptors, backing flanges PP-Steel, bolts and insulation half shells
- Separate Fittings type A needed for joining

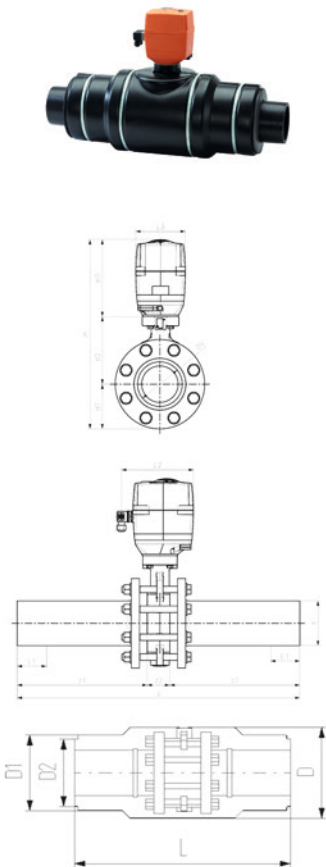

d (mm)	DN (mm)	PN	kv-value ($\Delta p=1$ bar) (l/min)	EPDM Code	Weight (kg)
110	100	10	6500	138 567 214	13.320
160	150	10	16500	138 567 217	22.346
225	200	10	39600	138 567 220	36.037

d (mm)	DN (mm)	D (mm)	D1 (mm)	D2 (mm)	L (mm)	L1 (mm)	L2 (mm)	L3 (mm)	H (mm)	H1 (mm)	H2 (mm)	H3 (mm)	z (mm)	z1 (mm)	z2 (mm)
110	100	310	188	168	552	72	179	122	460	104	167	190	696	320	56
160	150	358	259		720	90	179	122	535	143	203	190	895	412	72
225	200	409	325		776	110	179	122	580	170	210	200	996	462	73

d (mm)	DN (mm)	closest inch (inch)
110	100	4
160	150	6
225	200	8

COOL-FIT 4.0 Accessories



COOL-FIT 4.0 Assembly Aid-Kit

Model:

- For simplified mounting of COOL-FIT 4.0 Fitting on COOL-FIT 4.0 Pipe

d (mm)	D (mm)	Code	Weight (kg)	pieces/kit
32 - 225	90 - 315	799 738 501	5.600	2 / Dimension
32	90	799 738 511	0.384	6
40 - 50	110	799 738 512	0.456	6
63	125	799 738 513	0.504	6
75	140	799 738 514	0.564	6
90	160	799 738 515	0.636	6
110	180	799 738 516	0.708	6
160	250	799 738 519	0.620	4
225	315	799 738 522	0.760	4



COOL-FIT 4.0 Insulation for welding indicator-kit

Model:

- Type A suitable for COOL-FIT 4.0 Fittings d32-d110
- Type B suitable for COOL-FIT 4.0 Fittings d160 and coupler d225
- Type C suitable for COOL-FIT 4.0 Fittings d225 except coupler

d (mm)	Code	Weight (kg)	Type	pieces/kit
32 - 110	738 010 052	0.090	A	20
160 - 225	738 010 053	0.200	B	10
225	738 010 054	0.033	C	10



COOL-FIT 4.0 Sealing clamp-kit

Model:

- Supports the function of the top sealing lip of COOL-FIT 4.0 Fittings for vertical installations outdoor
- Material: stainless steel 304/V2A
- Color: black

d (mm)	D (mm)	Code	Weight (kg)	pieces/kit
32	90	738 013 013	0.250	6
40 - 50	110	738 013 014	0.300	6
63	125	738 013 015	0.300	6
75	140	738 013 016	0.300	6
90	160	738 013 017	0.300	6
110	180	738 013 018	0.300	6
160	250	738 013 021	0.390	6
225	315	738 013 023	0.450	6



COOL-FIT 4.0 Sealing tape

Model:

- Supports the function of the top sealing lip of COOL-FIT 4.0 Fittings for vertical installations outdoor
- 30m on a roll, 25mm width, buthylene rubber-based

d (mm)	D (mm)	Code	Weight (kg)
32 - 225	90 - 315	738 013 031	1.400

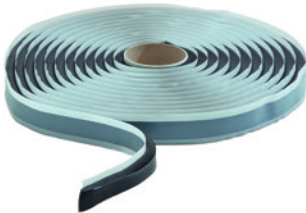

COOL-FIT 4.0 Transition of Insulation

Model:

- For a moistur-proof and vapour tight transition of insulations from COOL-FIT 4.0 to COOL-FIT 2.0
- 4.5m on a roll, buthylene rubber-based

d (mm)	D (mm)	Code	Weight (kg)
32-110	90-180	738 013 041	1.400

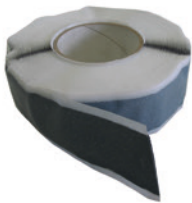

COOL-FIT 4.0 Sealing tape, d250 - d450

Model:

- For a water- and steam-tight sealing of inspection gaps in combination with shrink sleeves/ - sockets
- Sealing tape: 40mm width, buthylene rubber-based
- 30 m on a roll

D (mm)	d-d (mm)	Code	Weight (kg)	Closest inch (inch)
90 - 450	25 - 315	738 011 152	2.134	¾ - 12



COOL-FIT 4.0 Shrink socket PE, d250 - d450

Model:

- For a water- and steam-tight sealing in combination with buthylene rubber-based sealing tape
- Length: 100 mm
- "Heavy duty" version for high end applications
- For connections of the same pipe outer diameter

D (mm)	d (mm)	Code	SP	Weight (kg)	L (mm)
355	250	738 011 024	1	0.900	100
400	280	738 011 025	1	1.100	100
450	315	738 011 026	1	1.900	100
500	355	738 011 027	1	1.000	100
560	400	738 011 028	1	1.000	100
630	450	738 011 029	1	1.000	100



Cold shrink tape PE black

Model:

- For indoor use only
- Width (L) available in 100mm
- 15 m on a roll
- Shrinks without heat application

COOL-FIT 2.0 Adaptor fitting PE/Brass with male thread R

D (mm)	d-d (mm)	Code	Weight (kg)	L (mm)	Closest inch (inch)
90 - 450	25 - 315	738 011 107	1.400		¾ - 8



COOL-FIT 4.0 Hot shrink tape PE black

Model:

- For watertight sealing of outer pipe in underground installations
- Mastic backed
- 30 m on a roll
- Shrink with a burner or hot air gun
- Order sealing patches separately (738 011 109)

D (mm)	d-d (mm)	Code	Weight (kg)	L (mm)	Closest inch (inch)
90 - 630	25 - 450	738 011 108	3.000	150	¾ - 18

Aussenrohr/ casing pipe	Länge Schrumpfband length shrink tape
90	370
110	440
125	480
140	530
160	600
180	660
225	800
250	880
280	970
315	1080
355	1210
400	1350
450	1500
500	1660
560	1850
630	2070

Sealing patch

Model:

- For sealing of hot-shrink-tape in underground installations
- Mastic backed
- 1 patch needed per seal

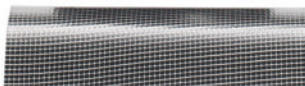

D (mm)	d-d (mm)	Code	Weight (kg)	L (mm)	Closest inch (inch)
90 - 630	25 - 450	738 011 109	0.100	150	¾ - 18

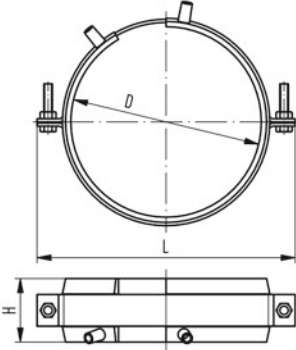

COOL-FIT 4.0 fixed point

Model:

- The product consists of two components namely electrofusion tapes and pipe brackets.
- Electrofusion welded tape as permanent connection to transmit the forces that occur in the pipe to the fixed point.
- The delivered pipe brackets are needed to deliver welding pressure during installation and give stability during operation.
- For welding, use an MSA2.x, MSA4.x, MSA 250, 300, 350, 400 or commercially available 220 V fusion machines.
- If you use an MSA fusion machine from GF Piping Systems, use the 799 350 339 adapter or the 790 156 032 y-cable set.
- Please take note of the maximum allowed forces for this version in the table below.
- **Fixed point brackets and cross braces have to be calculated and obtained by the installer. They are not included in the fixed point set from GF.**

D (mm)	d (mm)	Code	SP	Weight (kg)	L (mm)	H (mm)	max Force (kN)	Closest inch (inch)
90	32	738 912 013	1	0.895	170	60	2.0	1 ¼ - 1 ½
110	40 - 50	738 912 014	1	0.904	180	60	3.0 / 5.0	2
125	63	738 912 015	1	1.103	215	60	8.0	2 ½
140	75	738 912 016	1	1.188	220	60	10.0	3
160	90	738 912 017	1	1.177	255	60	10.0	4
180	110	738 912 018	1	1.530	255	60	10.0	4
250	160	738 912 021	1	1.957	335	60	10.0	6
315	225	738 912 023	1	2.388	400	60	10.0	8



COOL-FIT Y cables kit

- The COOL-FIT Y cables are used to speed up the installation of the fixed points electrofusion tapes. The Y cables allow the welding in parallel of 2 E-Tapes, halving the total duration of the fusion process.
- Compatible with all MSA Units

Type	Code	Weight (kg)
4 leads cable with 2mm plugs in output	790 156 032	0.385



COOL-FIT Cap PE black

Model:

- To seal the end of a COOL-FIT Plus pipe

d (mm)	D (mm)	D1 (mm)	Code	Weight (kg)	L (mm)	closest inch (inch)
250	355	265	733 960 185	0.155	35	10
280	400	300	733 960 186	0.185	35	10
315	450	335	733 960 187	0.225	35	12
355	500	370	733 963 188	0.269	35	14
400	560	420	733 963 189	0.269	35	16
450	630	470	733 963 190	0.269	35	18

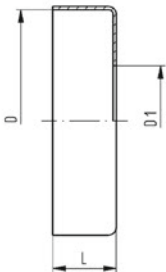

KLIP-IT pipe clip type 061 PP metric



Model:

- Material: clip and safety clip PP black, UV resistant
- d16 - d63: height designed for ball valve type 546 and 543
- **Minimum order quantity: standard packagings SP**

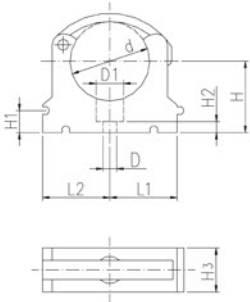

	d (mm)	d (inch)	Code	SP	Weight (kg)
*	10		167 061 003	10	0.003
*	12		167 061 004	10	0.003
*	16		167 061 035	10	0.007
*	20		167 061 036	10	0.007
*	25		167 061 037	10	0.009
*	32		167 061 038	10	0.012
	40		167 061 039	10	0.027
	50		167 061 040	10	0.031
	63		167 061 041	10	0.052
	75	2 ½	167 061 012	10	0.057
	90	3	167 061 013	10	0.092
	110	4	167 061 014	10	0.117
	125		167 061 015	10	0.180
	140	5	167 061 016	10	0.224
	160		167 061 017	10	0.242

	d (mm)	D (mm)	D1 (mm)	H (mm)	H1 (mm)	H2 (mm)	H3 (mm)	L1 (mm)	L2 (mm)	SC	closest inch (inch)
*	10	5	8	20	10	6	12	11	14	M4	¼
*	12	5	8	21	10	6	12	11	14	M5	¼
*	16	6	11	27	10	6	16	14	17	M5	⅜
*	20	6	11	27	10	6	16	17	19	M5	½
*	25	6	11	30	10	6	16	19	22	M5	¾
*	32	6	11	36	10	6	16	24	27	M5	1
	40	7	14	44	10	7	22	34	34	M6	1 ¼
	50	7	14	51	10	7	22	37	37	M6	1 ½
	63	9	17	64	10	10	25	45	45	M8	2
	75	9	17	58	10	10	25	52	52	M8	2 ½
	90	9	17	65	10	10	28	65	65	M8	3
	110	9	17	75	10	10	28	79	79	M8	4
	125	9	17	90	10	10	32	88	88	M8	
	140	9	17	110	10	10	32	98	98	M8	5
	160	9	17	108	10	10	32	109	109	M8	6



KLIP-IT spacer type 061 PP

Model:

- For pipe clips type 061/061H, PP black, UV resistant
- **Minimum order quantity: standard packaging SP**

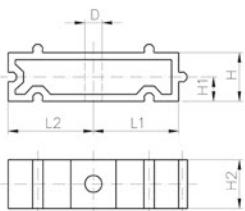

d (mm)	Inch (inch)	Code	SP	Weight (kg)	D (mm)	L1 (mm)	L2 (mm)	H (mm)	H1 (mm)	H2 (mm)	SC
10 - 12	¼ - ½	167 061 153	10	0.003	5	11	14	20	10	12	M4
16	⅜	167 061 155	10	0.005	6	14	17	20	10	16	M5
20	½	167 061 156	10	0.005	6	17	19	20	10	16	M5
25	¾	167 061 157	10	0.007	6	19	22	20	10	16	M5
32	1	167 061 158	10	0.006	6	24	27	20	10	16	M5
40	1 ¼	167 061 159	1	0.015	7	34	34	20	10	22	M6
50	1 ½	167 061 160	10	0.017	7	37	37	20	10	22	M6
63	2	167 061 161	10	0.020	9	45	45	20	10	25	M8
75	2 ½	167 061 162	10	0.027	9	52	52	20	10	25	M8
90	3	167 061 163	10	0.039	9	65	65	20	10	28	M8

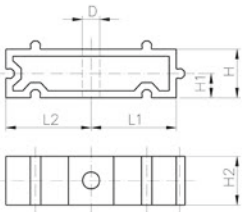

d (mm)	Inch (inch)	Code	SP Weight (kg)	D (mm)	L1 (mm)	L2 (mm)	H (mm)	H1 (mm)	H2 (mm)	SC
110	4	167 061 164	10 0.048	9	79	79	20	10	28	M8
125	4 ½	167 061 165	10 0.059	9	88	88	20	10	32	M8
140	5	167 061 166	10 0.065	9	98	98	20	10	32	M8
160	6	167 061 167	10 0.071	9	109	109	20	10	32	M8



Pipe clip type 060 PP metric

Model:

- Material: clip and safety clip PP black, UV resistant
- **Minimum order quantity: standard packaging SP or gross packaging GP**
- Accidental opening of the safety clip is not possible
- Clip and safety clip are not assembled in the packaging.
- Pipes with flanges can be installed directly

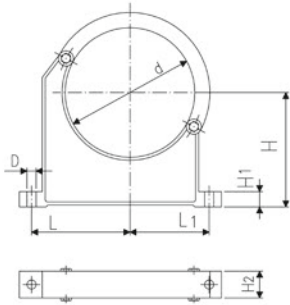

d (mm)	Code	SP Weight (kg)	D (mm)	L (mm)	L1 (mm)	H (mm)	H1 (mm)	H2 (mm)	SC	closest inch (inch)
90	167 060 038	10 0.144	9	89	71	105	15	33	M 8	3
110	167 060 039	10 0.158	9	94	80	115	15	33	M 8	4
125	167 060 040	10 0.249	11	116	91	130	20	35	M10	
140	167 060 041	10 0.260	11	121	98	130	20	35	M10	5
160	167 060 042	10 0.296	11	131	107	148	20	35	M10	6
180	167 060 043	10 0.327	11	143	115	163	20	35	M10	7
250	167 060 021	5 0.657	13	183	143	200	25	39	M12	9
315	167 060 023	5 0.805	13	219	172	225	25	39	M12	12
355	167 060 024	5 1.251	17	275	209	258	30	50	M16	14
400	167 060 025	4 1.031	17	300	228	288	30	50	M16	16



Tangit KS Cleaner

- Special cleaner for plastic fusion connections in the material of PP, PE, PVDF and PB
- Suitable for Tangit Rapid. Must not be used for solvent cementing
- DVGW approved
- DW 5290 BR 0464

Size	Code	Weight (kg)
1 liter	799 298 023	0.872



Marker

Type	Code	Weight (kg)
silver	799 350 364	0.010

COOL-FIT 4.0 Tools



COOL-FIT 2.0/4.0 Foam removal and peeling tool

Model:

- Tool for foam removal and peeling of COOL-FIT 2.0 and 4.0 pipes

d (mm)	Code	Weight (kg)
32-90	799 738 001	10.500
110-225	799 738 003	16.500
250-450	799 738 004	71.000



COOL-FIT 2.0/4.0 Powered foam removal and peeling tool

Model:

- Tool for foam removal and peeling of COOL-FIT 2.0 and 4.0 pipes
- For usage in combination with drill drivers (not included)

d (mm)	Code	Weight (kg)
32-63	799 738 201	10.500



Peeling tool RTC

- **Rotary peeler for reliable pipe preparation prior to electrofusion**
- Applicable on pipe ends and spigot ends of fittings
- **Scope of delivery 315:** 1 Scraper arm, 1 Self-centering chuck base, 1 Aluminium transport case
- **Scope of delivery 710:** 1 Scraper arm, 1 Self-centering chuck base, 2 Aluminium transport case

d-d (mm)	Code	Weight (kg)	Description
75 - 315	799 150 423	9.616	max. working-range 185 mm
355 - 710	799 300 757	31.400	max. working-range 530 mm



MSA 2.1 Automatic Electrofusion Unit with protocols retrieval

The MSA 2.1 automatic electro fusion unit combines light weight and high efficiency, thanks to its inverter technology and furthermore provides fusion documentation in PDF. The unit is extremely fast and simple, with three basic operations required to operator: connect, scan, start the fusion. It is robust, safe and ergonomic.

All is meant to simplify the job: the barcode scanner, for long distance reading, the cooling system to joint in series, the icon system, to keep the interaction between user and machine intuitive. The entire welding process is controlled and regulated with energy output compensation depending on ambient temperature and the indication of cooling time.

The unit has 1000 protocols permanently stored in the internal memory. The user can copy the fusion reports in an USB stick to print them out in PDF format.

Scope of delivery includes: transport box, angle adapters (4.0 mm and 4.7 mm), operating instructions, START/STOP badge and USB memory stick with PC applications.

Technical Data:

- Operating temperature: -20°C to +50°C
- Mains voltage: 230V (190V - 265V)
- Mains frequency: 50-60 Hz
- Fusion voltage: 8-42 V (48 V)
- Fusion data input mode: bar code, manual
- Fusion current: 90 A (max)
- Suggested power generators: 3.5 kVA
- Fittings range: d20-1200 mm
- Protocols format: PDF and binary (compatible with mini Welding Book)
- USB Port: Type A
- Protection factor: Class 1 / IP 65
- Mains cable: 4 m
- Fusion cable: 4 m
- Weight: ca. 11.9 kg
- Display: Graphical LCD, adjustable contrast
- Independent from languages

	Type	Code	SP	Weight (kg)
Barcode scanner, transport case, mini Welding Book		790 156 003	1	20.000
Barcode scanner, transport case, mini Welding Book, Swiss plug		790 156 006	1	20.000
Barcode scanner, transport case, mini Welding Book, 8m fusion cable		790 156 010	1	21.000



Long adapters

- Adapters for Electrofusion units with 4 mm connectors.
- Longer version, suitable for all COOL-FIT 4.0 dimensions.

Type	Code	Weight (kg)	Description
4,0 mm	790 128 035	0.058	Angle adapters pair, black



Double clamp with universal link

- Recommended for the installation of fittings COOL-FIT and ELGEF Plus
- The clamping allows installation without tension and avoids movement during fusion and cooling time
- The centrally located adjustable universal link allows installation of electrofusion couplers, elbows and reducers
- Works above, below and alongside the joint
- Adaptor for use with Tee-pieces available (see accessories)

d (mm)	d1 (mm)	Code	Weight (kg)	Description	L (mm)	B (mm)	H (mm)
40	200	799 301 490	4.200	Scope of delivery: 2 x V-block, 2 x Straight bar, 1 x Universal link, Transport bag (600x380x250)	960	290	230
160	630	799 301 496	14.100	Scope of delivery: 2 x V-block, 2 x Straight bar, 1 x Universal link, Transport bag (780x780x580)	1300	670	550



Quadruple clamp with universal link

- Recommended for the installation of fittings COOL-FIT and ELGEF Plus
- The clamping allows installation without tension and avoids movement during fusion and cooling time
- The centrally located adjustable universal link allows installation of electrofusion couplers, elbows and reducers
- Universal use; works above, below and alongside the joint
- Adaptor for use with Tee-pieces available (see accessories)

d (mm)	d1 (mm)	Code	Weight (kg)	Description	L (mm)	B (mm)	H (mm)
40	200	799 301 489	8.300	Scope of delivery: 4 x V-block, 2 x Straight bar, 1 x Universal link, Transport bag (600x380x250)	960	290	230
160	630	799 301 495	23.300	Scope of delivery: 4 x V-block, 2 x Straight bar, 1 x Universal link, Transport bag (780x780x580)	1300	670	550



Tee adaptor

- Suitable for clamping tool (799301489 - 495)

d (mm)	d1 (mm)	Code	Weight (kg)	Description	L (mm)	B (mm)	H (mm)
40	200	799 301 491	0.610	Tee adaptor	600	50	40
160	630	799 301 497	3.500	Tee adaptor	1070	75	60



V-block

- Suitable for clamping tool (799301489 - 495)

d (mm)	d1 (mm)	Code	Weight (kg)	Description	L (mm)	B (mm)	H (mm)
40	200	799 301 492	1.000	V-block complete	290	230	65
160	630	799 301 498	3.200	V-block complete	660	430	90



Bar extension

- Suitable for clamping tool (799301489 - 495)

d (mm)	d1 (mm)	Code	Weight (kg)	Description	L (mm)	B (mm)	H (mm)
160	630	799 301 499	1.000	Bar extension	1000	40	40

Worldwide at home

Our sales companies and representatives ensure local customer support in more than 100 countries.

www.gfps.com

Argentina / Southern South America

Georg Fischer Central Plastics Sudamérica S.R.L.
Buenos Aires / Argentina
Phone +54 11 4512 02 90
gfccentral.ps.ar@georgfischer.com
www.gfps.com/ar

Australia

Georg Fischer Pty Ltd
Riverwood NSW 2210
Phone +61 (0) 2 9502 8000
australia.ps@georgfischer.com
www.gfps.com/au

Austria

Georg Fischer Rohrleitungssysteme GmbH
3130 Herzogenburg
Phone +43 (0) 2782 856 43-0
austria.ps@georgfischer.com
www.gfps.com/at

Belgium / Luxembourg

Georg Fischer NV/SA
1600 Sint-Pieters-Leeuw / Belgium
Phone +32 (0) 2 556 40 20
Fax +32 (0) 2 524 34 26
be.ps@georgfischer.com
www.gfps.com/be

Brazil

Georg Fischer Sist. de Tub. Ltda.
04571-020 São Paulo/SP
Phone +55 (0) 11 5525 1311
br.ps@georgfischer.com
www.gfps.com/br

Canada

Georg Fischer Piping Systems Ltd
Mississauga, ON L5T 2B2
Phone +1 (905) 670 8005
Fax +1 (905) 670 8513
ca.ps@georgfischer.com
www.gfps.com/ca

China

Georg Fischer Piping Systems Ltd
Shanghai 201319
Phone +86 21 3899 3899
china.ps@georgfischer.com
www.gfps.com/cn

Denmark / Iceland

Georg Fischer A/S
2630 Taastrup / Denmark
Phone +45 (0) 70 22 19 75
info.dk.ps@georgfischer.com
www.gfps.com/dk

Finland

Georg Fischer AB
01510 Vantaa
Phone +358 (0) 9 586 58 25
Fax +358 (0) 9 586 58 29
info.fi.ps@georgfischer.com
www.gfps.com/fi

France

Georg Fischer SAS
95932 Roissy Charles de Gaulle Cedex
Phone +33 (0) 1 41 84 68 84
fr.ps@georgfischer.com
www.gfps.com/fr

Germany

Georg Fischer GmbH
73095 Albershausen
Phone +49 (0) 7161 302 0
info.de.ps@georgfischer.com
www.gfps.com/de

India

Georg Fischer Piping Systems Pvt. Ltd
400 083 Mumbai
Phone +91 22 4007 2000
Fax +91 22 4007 2020
branchoffice@georgfischer.com
www.gfps.com/in

Indonesia

PT Georg Fischer Indonesia
Karawang 41371, Jawa Barat
Phone +62 267 432 044
Fax +62 267 431 857
indonesia.ps@georgfischer.com
www.gfps.com/id

Italy

Georg Fischer S.p.A.
20063 Cernusco S/N (MI)
Phone +39 02 921 861
it.ps@georgfischer.com
www.gfps.com/it

Japan

Georg Fischer Ltd
530-0003 Osaka
Phone +81 (0) 6 6341 2451
jp.ps@georgfischer.com
www.gfps.com/jp

Korea

Georg Fischer Korea Co. Ltd
Unit 2501, U-Tower
120 Heungdeok Jungang-ro
(Yeongdeok-dong)
Giheung-gu, Yongin-si, Gyeonggi-do
Phone +82 31 8017 1450
Fax +82 31 217 1454
kor.ps@georgfischer.com
www.gfps.com/kr

Malaysia

George Fischer (M) Sdn. Bhd.
41200 Klang, Selangor Darul Ehsan
Phone +60 (0) 3 3122 5585
Fax +60 (0) 3 3122 5575
my.ps@georgfischer.com
www.gfps.com/my

Mexico / Northern Latin America

Georg Fischer S.A. de C.V.
CP 66636 Apodaca, Nuevo Leon / Mexico
Phone +52 (81) 1340 8586
Fax +52 (81) 1522 8906
mx.ps@georgfischer.com
www.gfps.com/mx

Middle East

Georg Fischer Piping Systems (Switzerland) Ltd
Dubai / United Arab Emirates
Phone +971 4 289 49 60
gcc.ps@georgfischer.com
www.gfps.com/int

Netherlands

Georg Fischer N.V.
8161 PA Epe
Phone +31 (0) 578 678 222
nl.ps@georgfischer.com
www.gfps.com/nl

New Zealand

Georg Fischer Ltd
5018 Upper Hutt
Phone +04 527 9813
Fax +04 527 9834
nz.ps@georgfischer.com
www.gfps.com/nz

Norway

Georg Fischer AS
1351 Rud
Phone +47 67 18 29 00
no.ps@georgfischer.com
www.gfps.com/no

Philippines

George Fischer Pte Ltd
Representative Office
1604 Pasig City
Phone +632 571 2365
Fax +632 571 2368
sgp.ps@georgfischer.com
www.gfps.com/sg

Poland

Georg Fischer Sp. z o.o.
05-090 Sekocin Nowy
Phone +48 (0) 22 31 31 0 50
poland.ps@georgfischer.com
www.gfps.com/pl

Romania

Georg Fischer Piping Systems (Switzerland) Ltd
020257 Bucharest - Sector 2
Phone +40 (0) 21 230 53 80
ro.ps@georgfischer.com
www.gfps.com/int

Russia

Georg Fischer Piping Systems (Switzerland) Ltd
Moscow 125040
Phone +7 495 748 11 44
ru.ps@georgfischer.com
www.gfps.com/ru

Singapore

Georg Fischer Pte Ltd
528 872 Singapore
Phone +65 6747 0611
Fax +65 6747 0577
sgp.ps@georgfischer.com
www.gfps.com/sg

Spain / Portugal

Georg Fischer S.A.
28046 Madrid / Spain
Phone +34 (0) 91 781 98 90
es.ps@georgfischer.com
www.gfps.com/es

Sweden

Georg Fischer AB
117 43 Stockholm
Phone +46 (0) 8 506 775 00
info.se.ps@georgfischer.com
www.gfps.com/se

Switzerland

Georg Fischer Rohrleitungssysteme (Schweiz) AG
8201 Schaffhausen
Phone +41 (0) 52 631 3026
ch.ps@georgfischer.com
www.gfps.com/ch

Taiwan

Georg Fischer Co. Ltd
San Chung Dist., New Taipei City
Phone +886 2 8512 2822
Fax +886 2 8512 2823
www.gfps.com/tw

United Kingdom / Ireland

Georg Fischer Sales Limited
Coventry, CV2 2ST / United Kingdom
Phone +44 (0) 2476 535 535
uk.ps@georgfischer.com
www.gfps.com/uk

USA / Caribbean

Georg Fischer LLC
92618 Irvine, CA / USA
Phone +1 714 731 8800
Fax +1 714 731 6201
us.ps@georgfischer.com
www.gfps.com/us

Vietnam

Georg Fischer Pte Ltd
Representative Office
Ho Chi Minh City
Phone +84 28 3948 4000
Fax +84 28 3948 4010
sgp.ps@georgfischer.com
www.gfps.com/vn

International

Georg Fischer Piping Systems (Switzerland) Ltd
8201 Schaffhausen / Switzerland
Phone +41 (0) 52 631 3003
Fax +41 (0) 52 631 2893
info.export@georgfischer.com
www.gfps.com/int

The information and technical data (altogether "Data") herein are not binding, unless explicitly confirmed in writing. The Data neither constitutes any expressed, implied or warranted characteristics, nor guaranteed properties or a guaranteed durability. All Data is subject to modification. The General Terms and Conditions of Sale of Georg Fischer Piping Systems apply.